



Thermo Scientific Orion 2100 Series

pH/ORP Analyzer and Conductivity Analyzer

UM-263639-001 • Revision B • January 2017

© 2013-2017 Thermo Fisher Scientific Inc. All rights reserved. All trademarks are the property of Thermo Fisher Scientific Inc. and its subsidiaries. Specifications, terms and pricing are subject to change. Not all products are available in all countries. Please consult your local sales representative for details.

No part of this publication may be reproduced, transmitted, transcribed, stored in a retrieval system, or translated into any language or any computer language, in any form or by any third party, without the prior written permission of Thermo Fisher Scientific.

Disclaimer

Thermo Fisher Scientific does not accept any responsibility for any damage caused to its products by unauthorized personnel. Use of non-Thermo Scientific™ reagents and/or replacement parts will void all warranties.

Contents

Section 1 General Information	1
Introduction	1
Features and Benefits	2
Principles of Operation	3
pH Analysis	3
ORP Analysis	3
Conductivity Analysis	4
Analyzer Diagram	4
Glossary	4
Two Channel Analyzer Configurations	5
Section 2 Analyzer Preparation	6
Unpacking the Analyzer	6
Mounting and Plumbing Instructions	7
Sample Requirements	8
Electrical Wiring	8
Safety Requirements	8
Warning Labels and Locations	8
Wiring the Analyzer	9
Terminal Assignments	11
Electrode Wiring Assignments	12
Installation of a New Electrode Cable	13
Ferrite Installation	13
Installation of a New pH Electrode	13
Installation of an ATC Probe	14
Installation of a New ORP Electrode	14
Installation of a New Conductivity Probe	14
Section 3 Analyzer Operation	15
Description of Basic Controls	15
Description of Keypad Icons	16
Use of the Setup Mode	17
Navigating Tips for the Setup Mode	17
Channel Specific Menu Options in the Setup Mode	18
Using Password Protection	18
Setup Mode Overview	19
Section 4 Calibration	49
Calibration Overview	49
pH Calibration Setup	49
pH Calibration Procedure	50
ORP Calibration Setup	56

Conductivity Calibration Setup	59
Calibration Abort Steps	67
Calibration Error Codes	67
Section 5 Analyzer Maintenance	69
Maintenance Schedule	69
Weekly Maintenance	69
Monthly Maintenance	70
Yearly Preventive Maintenance	70
Section 6 Troubleshooting	71
Diagnostics Mode	71
Slope Problems	76
Cell Constant Problems	77
Troubleshooting Matrix	78
Error/Event Codes	79
Resetting the Analyzer	82
Serial Number and Software Revision	83
Service and Repair	83
Section 7 Customer Service	85
Notice of Compliance	85
Statement of Conformity	86
WEEE Compliance	87
Terms and Conditions	87
Appendix	90
Default Values	90
Specifications	90
Ordering Information	93
Mounting Dimensions	94

1

SECTION 1 **General Information**

Introduction

This user guide covers operation, maintenance and troubleshooting for the Thermo Scientific Orion 2100 series pH/ORP and conductivity analyzers. These analyzers are available in a one pH channel configuration (Cat. No. 2102PH), two pH channel configuration (Cat. No. 2102PH2), one conductivity channel configuration (Cat. No. 2104CD), two conductivity channel configuration (Cat. No. 2104CD2) or a one pH channel and one conductivity channel configuration (Cat. No. 21PHCD2). A pH or conductivity module can be added by the operator to one channel configurations for the ultimate flexibility in measurement capabilities.

The 2100 series analyzers for pH/ORP, conductivity or a combination of both provide accurate and reliable measurements in ultra pure water as well as the harshest industrial environments. Offered in single channel or dual channel configurations and available with an optional digital communication board, these analyzers set a new standard for easy operation and measurement reliability. Combined with decades of superior Thermo Scientific Orion sensor technology, our systems provide rapid results with complete stability.

Developed over decades of expertise in ultra pure water analysis, our measurement and temperature compensation algorithms provide the highest level of accuracy across the most difficult high purity measurements. Understanding the challenges of cycle chemistry, our system provides cation and ammonia/ETA compensation for customizing to your plant's requirements. When deionized water production requires compensation for HCl, NaOH, and H₂SO₄, the 2100 series analyzers perform without exception every time.

Markets

- Power generation
- Pulp and paper
- Bottled and municipal water
- Wastewater
- Process and industrial water

Applications

- High purity applications to wastewater effluent
- Rugged industrial environments
- Process optimization and control applications

Features and Benefits

Single and dual channel configurations are available for pH/ORP and conductivity, or a combination of both, offering flexibility for your needs.

- Easy to operate and calibrate – the system walks you through the step-by-step calibration process, ensuring a successful calibration the first time and every time
- Fastest, most stable measurements limit unnecessary calibration cycles due to drift with superior Thermo Scientific Orion sensor technology
- Measurements at a glance from any distance for even the lowest light conditions using the large operator friendly backlit display
- Advanced user interface with detailed calibration, measurement and diagnostic menus
- Ultra pure water compensation algorithms for low ionic strength waters
- Cation and ammonia/ETA compensation to customize for various cycle chemistries
- Password protection with supervisor to operator multi-level access – protects setup parameters and calibration data with simple view access
- Expandable platform – single channel modules for second channel monitoring of pH/ORP or conductivity add measurement loops with plug in ease
- Optional digital communication module available for integration into your facility's digital plant architecture
- Analog outputs (4 standard) are isolated and include both 0 to 20 mA or 4 to 20 mA ranges, with option for linear or logarithmic scaling
- Rugged NEMA 4X ½ DIN custom enclosure suitable for panel mounting (standard) or pipe mounting
- Easy installation has your plant up and running in minutes
- Analyzer can be used with a variety of pH, ORP and conductivity sensors for maximum flexibility

Principles of Operation

pH Analysis

The pH electrode responds logarithmically to changes in the solution pH. This response is described by the Nernst equation:

$$E = E_o + 2.3 (RT/nF) \log aH^+$$

Where:

- E = measured electrode potential, mV
- E_o = reference potential, mV
- R = ideal gas constant
- T = temperature of sample, degrees Kelvin
- n = valence of ionic species (+1 for pH)
- F = Faraday's constant
- $\log aH^+$ = pH

The above equation indicates that the measured potential varies with both temperature and the solution pH value. In order to eliminate error caused by fluctuations in sample temperature, the analyzer constantly updates temperature corrections from data supplied by the ATC probe.

From the Nernst equation, the theoretical response of pH electrode to a ten-fold change in concentration at 25 °C is 59.16 mV. This is referred to as the electrode slope (S). Most electrodes, however, do not exhibit a theoretical slope. Therefore, the analyzer is calibrated to determine its actual value. Two buffers are used to provide information necessary for the analyzer to compute the actual slope and E_o for use during sample analysis.

ORP Analysis

The ORP readings can be reported using the absolute mV values or the E_H mV values. E_H mV values give the corresponding mV values that would be obtained using a Standard Hydrogen Electrode (SHE), also known as the Normal Hydrogen Electrode (NHE). An ORP standard allows operators to correlate measurements to the E_H mV value with an ORP electrode.

$$E_H = E_o + C$$

Where:

- E_H = oxidation reduction potential of the sample relative to the standard hydrogen electrode
- E_o = potential developed by the redox electrode
- C = potential developed by the reference electrode relative to standard hydrogen electrode

Conductivity Analysis

A conductivity probe is formed by two square electrodes spaced a certain distance apart. The cell constant (K) is defined as the ratio of the distance between the electrodes (d) to the electrode area (A). However, the fringe-field effect (AR) alters the electrode area, therefore $K = d / (A + AR)$. It is normally impossible to measure the fringe-field effect, so the actual cell constant of a conductivity probe is calculated using a standard solution with a known conductivity value. Calibration is essential since the cell constant can vary as much as 10% from the nominal cell constant and the actual cell constant may change over time. Calibration frequency depends on the type of conductivity probe and the application. The most common methods of calibration are automatic or direct calibration.

An automatic calibration is performed by entering the nominal cell constant in the analyzer, immersing the conductivity probe in a conductivity standard and initiating the calibration. When the reading stabilizes, the analyzer displays the calibration standard value at 25 °C. Once the calibration is accepted, the analyzer calculates and displays the actual cell constant.

A direct calibration is performed by immersing the conductivity probe in a calibration standard and then entering the conductivity standard value at the measured temperature so the correct cell constant value is displayed. A direct calibration requires a chart of the calibration standard values at different temperatures or the calibration can be performed with the calibration standard at 25 °C.

A manual calibration is performed by immersing the conductivity probe in a calibration standard and then entering the cell constant value so the correct conductivity standard value at the measured temperature is displayed. A manual calibration requires a chart of the calibration standard values at different temperatures or the calibration can be performed with the calibration standard at 25 °C.

Analyzer Diagram

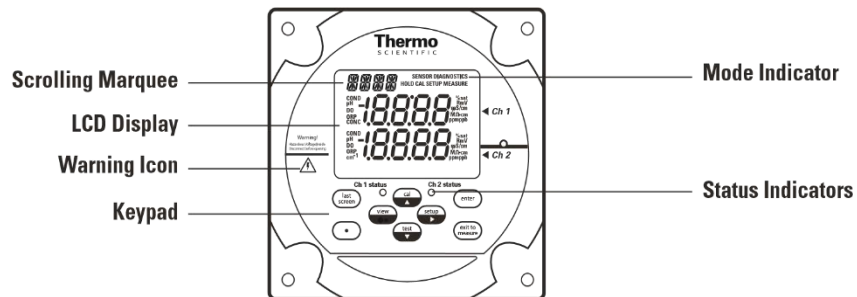

Glossary

pH or ORP Electrode – Senses the pH or ORP in the sample and produce an electrical potential dependent on sample pH or ORP.

Conductivity Probe – Measures the conductance of the sample solution for all dissolved ionic species.

Reference Electrode Filling Solution Bottle – Provides constant flow of electrolyte solution through the reference electrode for maximum stability.

ATC Probe – Measures the sample temperature and inputs the data to a microprocessor for automatic temperature compensation (ATC).

LCD Display – Provides digital readouts of concentration, temperature, millivolts and error codes.

Keypad – Consists of five mode keys, four prompt indicator lights, two scroll keys and one key for entering data. Mode and error indicators are also incorporated on keypad.

Status Indicator – Two LED lights that illuminate according to current status of the analyzer.

Green Light:	Indicates that system is in correct working condition.
Yellow Light:	Indicates a warning, system in hold or that maintenance is required.
Red Light:	Indicates that something is seriously wrong.

Note: When either the yellow or red LED is lit, there may be an entry in the diagnostics mode that indicates the error. The logging feature must be initiated in the setup mode. Refer to Section 3, Use of the Setup Mode for instructions.

Two Channel Analyzer Configurations

A pH/ORP module or conductivity module can be added by the operator to the second channel of the Thermo Scientific Orion 2100 series pH/ORP and conductivity analyzers for the ultimate flexibility in measurement capabilities. The 2100 series pH/ORP and conductivity analyzers provide accurate and reliable measurements in ultra pure water as well as the harshest industrial environments. Combined with decades of superior Thermo Scientific Orion sensor technology, our systems provide rapid results with complete stability.

Cat. No.	Description
2100PH2	Second channel module for pH/ORP
2100CD2	Second channel module for conductivity

When a pH/ORP module or conductivity module is installed on the second channel of a 2100 series pH/ORP or conductivity analyzer, refer to the *Thermo Scientific Orion 2100 Series pH/ORP Analyzer and Conductivity Analyzer User Guide* for detailed instructions on operating the pH/ORP or conductivity analyzer. Visit www.thermofisher.com/water to download any of the 2100 series analyzer user guides.

2

SECTION 2 Analyzer Preparation

WARNING: The instructions provided in this user guide are recommendations from the manufacturer to ensure safe and correct operation of the analyzer. If the analyzer is not used as recommended by the manufacturer this can lead to incorrect operation or injury.

Unpacking the Analyzer

Thermo Scientific Orion analyzers are assembled, tested and packaged with great care. Refer to Figure 1.

Report any obvious damage of shipping container to carrier and hold for inspection. The carrier (not Thermo Fisher Scientific) is responsible for any damage incurred during shipment.

1. Open the outer box. If the analyzer is purchased as a kit, the electrodes and accessories that are included with the kit will be in this box.
2. Open the inner box. This box should contain the analyzer, the options kit, user guide CD and appropriate literature.
3. Carefully place the analyzer at a convenient location until proper installation can be completed.

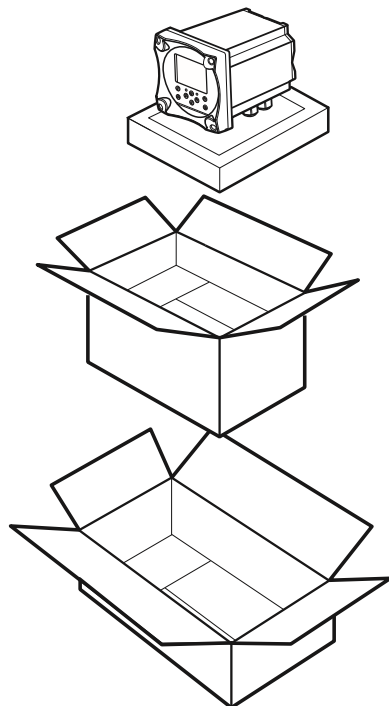

Figure 1: Unpacking the Analyzer

Mounting and Plumbing Instructions

Refer to the Appendix, Mounting Dimensions section.



WARNING: Do not connect power prior to the mounting and plumbing of the analyzer.

Recommendations

- Select a site for the analyzer that allows it to be permanently bolted. Be sure that there is ready access to the electronic controls and electrodes.
- The analyzer location must permit connection to an AC power supply and any connections for output devices.
- The electrodes/probes should be mounted as close to the sampling point as possible. This ensures the fastest possible response to a changing sample condition. Refer to the Appendix, Sample Conditions section.

Instructions

1. Carefully lift the analyzer and bolt it into place, using either the pipe mounting kit or the sample panel mounting kit.

The system can also be mounted using the standard mounting plate.

Sample Requirements

Additional information is listed in the Appendix, Specifications section.

Flow rate – 50 to 100 mL/minute.

Pressure – 8 to 100 psig, consult Technical Support for details on sample handling if pressure is outside range.

Temperature – The temperature range is sensor dependent.

Electrical Wiring

The warning icon highlights important information that should be strictly followed when using the analyzer for your own safety. Failure to follow these instructions may result in injuries.



WARNING: Read and observe the following safety recommendations.

Safety Requirements

- Prior to wiring, a switch or circuit breaker for disconnecting the analyzer from power supply should be installed.
 - The switch should be in close proximity to the analyzer and with easy reach of the user.
 - The switch should be marked as the disconnecting device for the analyzer.
- To reduce the risk of shock hazard, disconnect the power prior to opening the analyzer.
- Before connecting the analyzer to the main, make sure that the voltage lies within either range: 100-120V 200mA / 200-240V 100mA; 50-60 Hz AC.
- Cutting off the power by disconnecting power source will not reset the analyzer. This analyzer incorporates a non-volatile memory and will maintain calibration and settings after power failure. Battery power is supplied to the display for the date and time functions.
- If a repair is required, or to arrange Return Material Authorization, call Technical Support or contact your local authorized dealer.
- Installation and wiring of the analyzer may only be carried out in accordance with applicable local and national codes per this user guide.
- Be sure to observe the technical specifications and input ratings.

Warning Labels and Locations



WARNING: The following section provides important information that should be strictly followed when using the analyzer for your own safety. Failure to follow these instructions may result in injuries.

The safety warning icons are used in two locations on the analyzer.

- Faceplate – Refer to Figure 2.

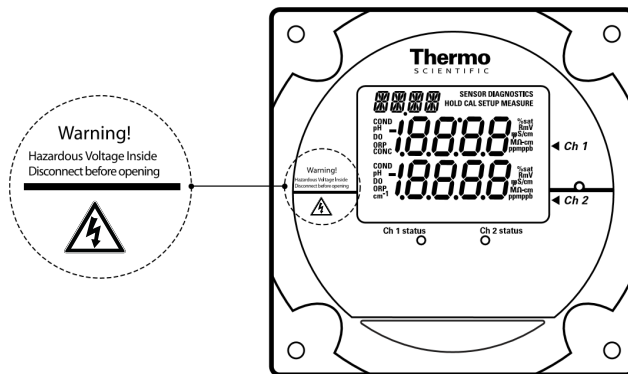

Figure 2: Faceplate

- Power supply – Refer to Figure 3.

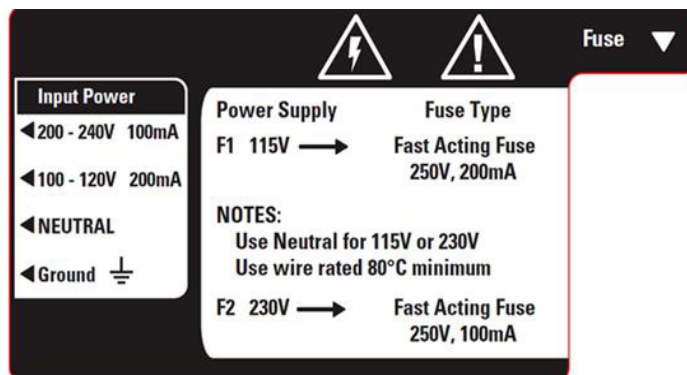

Figure 3: Power supply

Note: Replace the fuse only with a fuse of same rating.

Wiring the Analyzer



WARNING: Read and observe the following requirements. If you install the wrong fuse for your system, you could damage the analyzer. Make sure that you select the correct fuse rating and discard the additional fuses supplied in the fuse kit.

Required Tools

- Options kit – includes fuses, cable glands, conduit fitting and green screw terminal.
- Phillips head screwdriver.
- 2 mm blade flat-head screwdriver.

Figure 4: Electronics Enclosure with Cable Glands

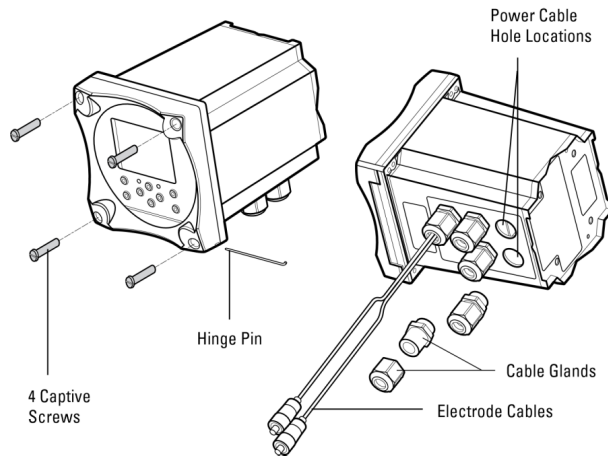

1. Open the faceplate – loosen the four screws using a Phillips head screwdriver. The electronics faceplate will open via the hinge pin connection.
2. Remove one or two of the two unused cable glands as required for wiring power cable or auxiliary connections. Power cable optional hole locations are shown in Figure 4.
3. Select and install the appropriate size cable gland or conduit fitting as required.
4. Feed the power cable through the conduit or cable glands as required.

Figure 5: Terminal Connector Location

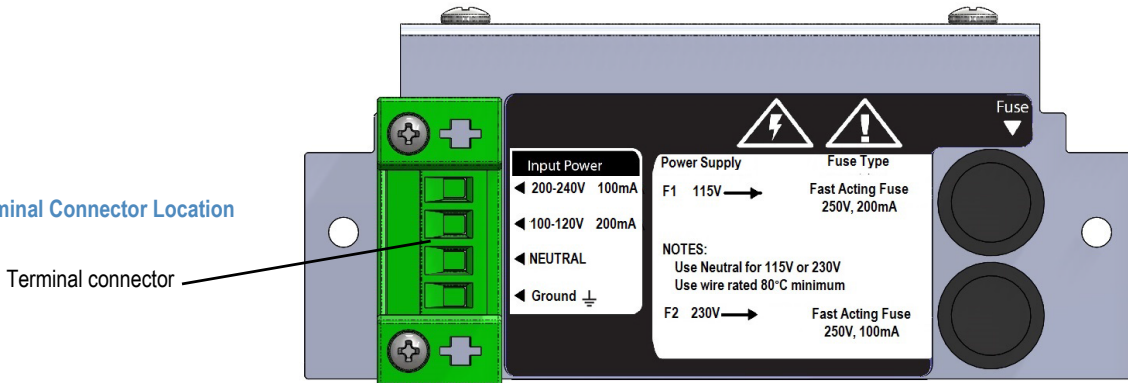

5. Wire the power cable to the green screw terminal connector from the options kit. Select correct terminal for hot conductor depending on line voltage, insert ground wire into the correct terminal and connect the other cable to the neutral terminal. Refer to Figure 5 for terminal connector location.
6. Plug the terminal connector into the power supply. Refer Figure 3.
7. The universal power supply uses both fuses in the fuse kit. Install by inserting the fuse in the fuse holder and secure it using the twist and lock method. The fuses are clearly labeled with the appropriate voltages for your system. Refer to Figure 3 and Figure 5 for the correct fuse holder positions. Refer to the table below for fuses required.

AC Voltage	Fuse Rating
115V	200mA, 250V, Fast Acting
230V	100mA, 250V Fast Acting

Terminal Assignments

Terminal Layout		Terminal Layout		Terminal Layout		Terminal Layout	
1	mA1 output	9	Relay 1	26	Sensing electrode	28	Do not connect
2	GND common ground	10	Relay 1	27	Do not connect	29	Do not connect
3	mA2 output	11	Relay 2			30	Preamp power
4	Air pump (ISE only)	12	Relay 2			31	Preamp ground
5	Air pump (ISE only)	13	Relay 3			32	Shield
6	Shield ground for conductivity	14	Relay 3			33	Shield
7	Do not connect	15	Do not connect			34	Jumper to pin 26 when using preamp
8	Do not connect	16	Temperature ground				
		17	Temperature drive				
		18	Temperature sense				
		19	Solution ground				
		20	Conductivity drive +				
		21	Conductivity sense+				
		22	Conductivity sense+				
		23	Conductivity drive +				
		24	Reference electrode				
		25	Jumper to pin 24 when using preamp				

Figure 6: Terminal Assignments

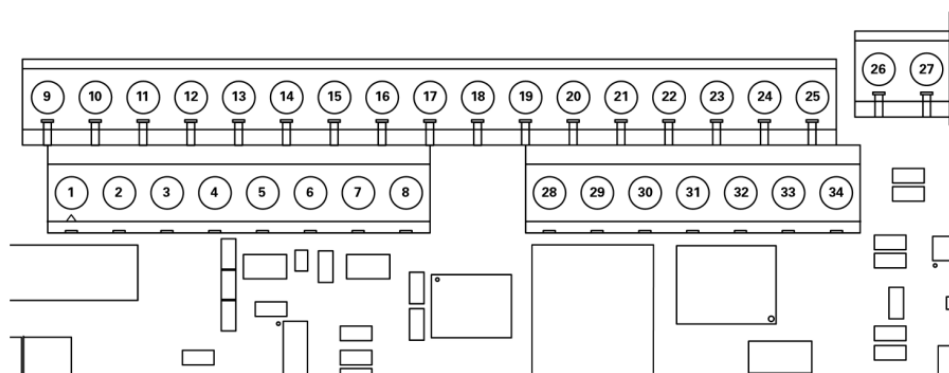

Electrode Wiring Assignments

2001SC pH Electrode		
24	Reference electrode	Connect black wire
26	Sensing electrode	Connect clear wire

2100TP Temperature Probe		
16	Temperature ground / thermister	Connect white wire
17	Temperature drive / thermister	Connect green wire
19	Solution ground	Connect red wire

2001TM Temperature Probe		
16	Temperature ground / thermister	Connect white wire
17	Temperature drive / thermister	Connect green wire, jumper 17 and 18
18	Temperature sense	Jumper to 17
19	Solution ground	Connect red wire

110250 ORP Electrode		
19	Solution ground	Connect black wire
24	Reference electrode	Connect purple wire
26	Sensing electrode	Connect coax center wire

2002CC and 2002SS Conductivity Probes		
6	Shield ground for conductivity	Connect clear wire
16	Temperature ground / thermister	Connect white wire
17	Temperature drive / thermister	Connect black wire
20	Conductivity drive +	Connect orange wire
21	Conductivity sense +	Connect red wire
22	Conductivity sense -	Connect green wire
23	Conductivity drive -	Connect blue wire

Ion Selective Electrode (ISE)		
26	Sensing electrode	Connect clear wire
33	Shield	Connect black wire

Reference Electrode (ISE)		
24	Reference electrode	Connect clear wire
32	Shield	Connect black wire

Note: Only reference the wiring configurations that are applicable to your analyzer and electrodes.

Installation of a New Electrode Cable

1. Unpack the electrode cable.
2. Feed the tinned wire through a cable gland assembly with the holes (2 or 1).
3. Follow the terminal assignments shown in Figure 6 for the proper electrode cable wiring location.

Ferrite Installation

1. Open the ferrite using a flat tip screwdriver to lift the latch of the ferrite.
2. Feed the cable wires through the center of the ferrite and then loop the cable wires around the ferrite core and through the center of the ferrite again.
3. Place the ferrite at the bottom of the analyzer chassis, near its edge. Adjust the ferrite location on the cable so the ferrite is near the top of the cable.



Figure 7: Ferrite Installation

Installation of a New pH Electrode

1. Unpack the ROSS[®] 2001SC pH electrode and carefully remove it from the storage cap. The pH electrode must be used in conjunction with the automatic temperature compensation (ATC) probe (Cat. No. 2100TM).
2. Prepare the electrode according to the instruction sheet or manual that is packaged with the electrode.
3. Plug the electrode cable into the top of the electrode. Be sure to push back black cap to verify a secure connection between male and female pin connection prior to tightening.
4. Tighten screw cap connection to cable.

Note: Do not twist the cable while tightening the connection. Twisting may cause damage requiring premature replacement of the cable.

Installation of an ATC Probe

1. Install the automatic temperature compensation (ATC) probe (Cat. No. 2100TM) to the correct terminal for temperature.

Installation of a New ORP Electrode

1. Unpack the ORP electrode and carefully remove it from the storage cap. The ORP electrode must be used in conjunction with the automatic temperature compensation (ATC) probe (Cat. No. 2100TM).
2. Prepare the electrode according to the instruction sheet or manual that is packaged with the electrode.
3. Plug the electrode cable into the top of the electrode. Be sure to push back black cap to verify a secure connection between male and female pin connection prior to tightening.
4. Tighten screw cap connection to cable.

Note: Do not twist the cable while tightening the connection. Twisting may cause damage requiring premature replacement of the cable.

Installation of a New Conductivity Probe

1. Unpack the conductivity probe from the shipping box.
2. Prepare the probe according to the instruction sheet or manual that is packaged with the electrode.
3. Plug the electrode cable into the top of the probe. Be sure to push back black cap to verify a secure connection between male and female pin connection prior to tightening.
4. Tighten screw cap connection to cable.

Note: Do not twist the cable while tightening the connection. Twisting may cause damage requiring premature replacement of the cable.

3

SECTION 3 Analyzer Operation

Description of Basic Controls

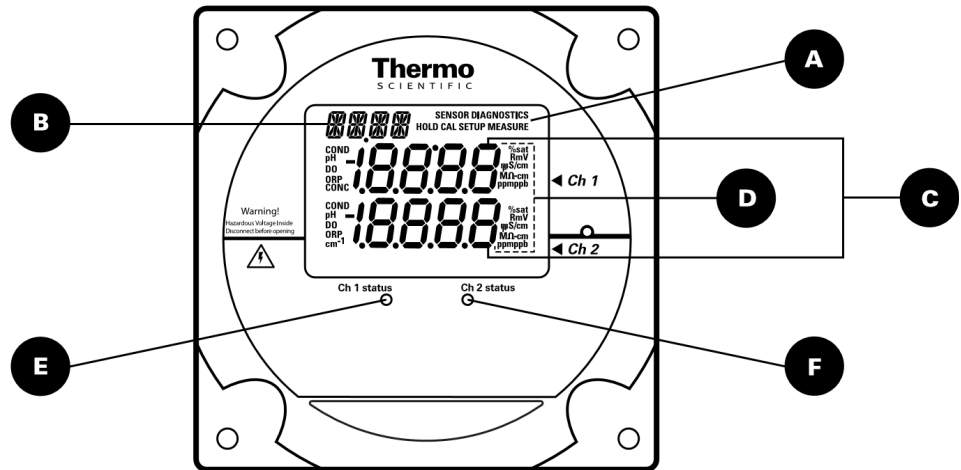



Figure 8: Faceplate

	Parameter	Location on Display	Options	Default
A	Mode Indicator	Top right corner of display	HOLD, CAL, SETUP, MEASURE, DIAGNOSTIC	MEASURE
B	Marquee Display	Top left corner of display	Analyzer provides prompts for operator using the scrolling message	
	Temperature Display		Celsius	In the measure mode, if an ATC probe is connected the default is the actual measured temperature and if no ATC probe is connected the default is 25 °C.
C	Main Data Display	Middle line and bottom line of display	pH/mV board: pH or mV Conductivity boards: conductivity, resistivity, salinity, concentration or TDS	Depends on type of board installed and selected measurement parameter
D	Measurement Units	Left and right side of middle and bottom display lines	pH/mV boards: pH and mV Conductivity boards: $\mu\text{S}/\text{cm}$ or mS/cm (conductivity), $\text{M}\Omega\text{-cm}$ (resistivity), SAL1 or SAL2 in the marquee (salinity), PCT1 or PCT2 in the marquee (concentration) and TDS1 or TDS2 in the marquee (TDS)	Depends on type of board installed and selected measurement parameter
E	Channel 1 Status Indicator	Below display screen, to the left of 	Green LED indicates that channel is OK Orange LED indicates a channel warning Red LED indicates a channel failure	At initial installation, the red LED indicates that the electrode or probe needs to be installed and calibrated.
F	Channel 2 Status Indicator	Below display screen, to the right of 	Green LED indicates that channel is OK Orange LED indicates a channel warning Red LED indicates a channel failure	At initial installation, the red LED indicates that the electrode or probe needs to be installed and calibrated.

Description of Keypad Icons

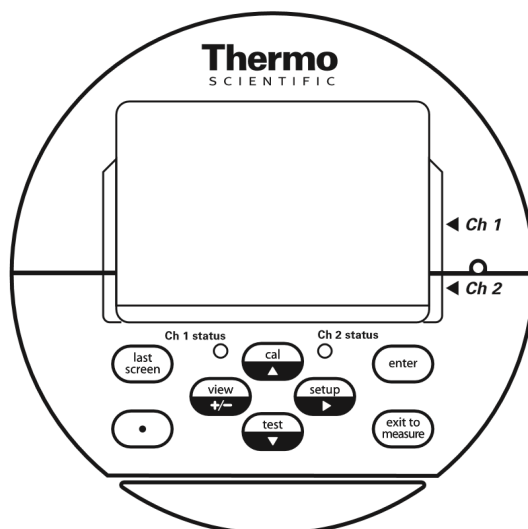













Figure 9: Keypad Icons









Key	Parameter/Mode	Action	Operational Selections
	Enters calibration mode	Calibration mode with operator prompts	Depends on type of board installed
	Scrolls up digit numbers Scrolls up through a list of options in setup and cal modes	Use to edit numeric values Use to select available options	0 through 9 selectable by digit, first digit sometimes selectable 0 through 19
	Enters setup mode	System setup mode at the last parameter used by the operator	PASS, DATE, TIME, LOG, RSET, DISP, CH1, CH2, MDL, MEAS, HOLD, TCMP, TADJ, ALRM, mA1, mA2, mADJ, TEST, CAL, PH, COND
	Moves to the next digit	Use to edit values	When moved to final digit, the system will wrap around to first digit
	Enters test mode	Use to advance through sequence of displays DIAGNOSTICS will appear in top right of screen	
	Scroll down digit numbers Scroll down through a list of options in setup and cal modes	Use to edit numeric values Use to select available options	0 through 9 selectable by digit, first digit sometimes selectable 0 through 19
	Enters log view mode	Use to view data in calibration, measure and status logs	
	+/- function	Enters negative/positive sign when editing numbers	
	Enter function	Use to accept value or selection displayed on screen and store value or selection in memory	
	Enter function (in test mode only)	Use in test mode to display additional information for selected menus	
	Exit to measure function	Use to exit setup or cal modes and enter the measure mode	Analyzer automatically enters measure mode when first turned on and after calibration
	Last screen function	Use in setup and test modes to return to the previous screen or menu	
	Decimal point function	Use to set the decimal point position in certain menus with numbers that require a decimal point	

Use of the Setup Mode



Before the first sample measurements can be taken, the setup mode should be programmed and a successful calibration must be performed by the operator and stored in the memory of the analyzer.



Navigating Tips for the Setup Mode

- Press  to enter the setup mode:
 - SETUP appears in the mode indicator screen.
 - HOLD is displayed while in the setup mode.
 - The analyzer will enter the setup mode at the last menu that was used by the operator.
- Press  and  to loop through the menu options.
- Press  to select the desired menu option and set the menu option parameters.

- Press  and  to:
 - Scroll between On and OFF for the selected menu option.
 - Scroll and set the first digit value to 0 through 19.
 - Scroll and set the remaining digit values to 0 through 9.
- Press  to move to the next digit (scroll right) to set each digit value (4 digits maximum).
- Press  to save the entered parameter for the selected menu option.
- Press  to exit the current screen and return to the previous screen.
- Press  to exit the setup mode and return to the measure mode. If  is pressed,  will not return the operator to the setup mode. The operator must reenter the setup mode by pressing .

Channel Specific Menu Options in the Setup Mode

If a single channel analyzer is in use, all of the menu options are accessible by pressing  /  in the setup mode. The system will loop through the menu options and all of the menu options are in the same level of the setup mode.

If a two channel analyzer is in use, only the general menu options are accessible by pressing  /  in the setup mode. The channel 1 and channel 2 specific menu options must be accessed by selecting the CH1 or CH2 menu options in the setup mode. The channel specific menu options are in the second level in setup mode. If a two channel analyzer is in use, make sure to program both the channel 1 and channel 2 menu options in the setup mode.

Using Password Protection

The default password is 0000 – indicates password protection has not been activated.

System password: Management secured password protection of setup mode and calibration process.

Calibration password: Operator secured password for protection of calibration process only.

If password(s) are activated:



- System prompts operator to enter system password:
 - Marquee: ENTER PASSWORD
 - Main display top: PASS
 - Main display bottom: 0000 (flashing)
- Correct password – Allows operator to enter setup mode for custom programming options.
- Incorrect password – Password incorrect or not entered correctly.

- System password:
 - Marquee: SYSTEM PASS INCORRECT
 - Main display: E035
- Calibration password:
 - Marquee: CAL PASS INCORRECT
 - Main display: E034
- Verify password and re-enter it.

If password(s) are de-activated:

- System enters the setup mode at the last setup menu option used by the operator.
 - Marquee: Flashes current menu option
 - Main display: SEL SCrn

Setup Mode Overview

The setup mode features programmable menu options. The order of the menu options is dependent on the direction the operator scrolls by pressing  or . The menu options are listed below by pressing .

General Setup Mode Menu Options

The following menu options are displayed in the main setup mode of one and two channel analyzers.

PASS

Set either of two password options:

- System password – Setup settings protected, accessed by authorized operators only
- Calibration password – Calibration menu data is protected, accessed by authorized operators only
- Default password is 0000 – Disables both passwords
- Forgot your password? Contact Technical Support at 1-800-225-1480

DATE

Set the date in US or Europe format:

- Enter month, day and year
- Default date – System will continue to keep date and time due to battery backup, operator must set in accordance to local time zone
- If the battery is removed, the system will show 01/01/2000

TIME

Set the time:

- Enter hour and minutes in 24 hour format
- Default time – System will continue to keep date and time due to battery back up, operator must set in accordance to local time zone
- If the battery is removed, the system will show 00:01

LOG

Set the data logging interval for measure log (calibration and error logs are accessed in the test mode):

- Set the log interval as hour:minute (HH:MM)
- Default log interval is 00:00 – logging disabled
- Minimum log interval is 1 minute; maximum log interval is 99 hours and 59 minutes

RSET

Reset the analyzer to factory defaults for setup parameters:

- Used to troubleshoot the system (a hard reset can be performed if the keypad and software are not responding, refer to Section 6, Resetting the Analyzer)



WARNING: Resetting the analyzer will lose all stored information including relay, logs and calibration settings.

DISP

Set the automatic lighting options for the backlit display:

- AUtO – Brightness will change in response to ambient light source
- On – Backlit display is always on
- OFF – Backlit display is always off
- Default display – AUtO

Channel Specific Setup Mode Menu Options

If a two channel analyzer is in use, the following menu options are specific to the channel that is selected by the operator. The operator must select the channel number in the main setup mode (CH1 or CH2) and the menu options that are relative to the measurement capability of that channel will be displayed.

CH1 or CH2

If a one channel analyzer is being used, the CH1 and CH2 menus will not be shown.

MDL

for pH/ORP

Set the parameter that will be displayed in the measure mode:

- pH/ORP – Select pH or ORP (mV) as the measurement parameter

MDL

for conductivity

Set the parameter that will be displayed in the measure mode:

- Conductivity – Select conductivity, resistivity, salinity, concentration or TDS as the measurement parameter
- If concentration is selected as the measurement parameter, select NaCl, HCl, NaOH, H₂SO₄ or NO₃ as the concentration setting
- If total dissolved solids (TDS) is selected as the measurement parameter, set the TDS factor from 0.00 to 10.00 mg/L

MEAS

for pH

Set the mV display option, decimal places displayed when in the pH measure mode and the isopotential point used when in the pH measure mode (menu available only for analyzers with a pH/ORP board installed):

- Enable mV values to be displayed on the second line
 - Scroll between On or OFF
 - Default mV setting – OFF
- Set the number of decimal places displayed in the pH measure mode
 - Scroll between 1 or 2 decimal places
 - Default decimal places – 2
- Set the pH filter algorithm
 - Scroll between Stnd (standard) or UP (ultrapure)
 - Default pH filter type – Stnd
- Set the pH isopotential point
 - Enter the pH isopotential point value
 - Default pH isopotential point – 7.00

MEAS

for conductivity

Set the mV display option (menu available only for analyzers with a pH/ORP board installed):

- Enable mV values to be displayed on the second line
- Scroll between On or OFF
- Default mV setting – OFF

HOLD

Set the time that the system will remain on hold before the actual measurements are displayed after a calibration:

- Once the hold time expires, the system implements any programmed changes to settings in the setup mode
- After a calibration, the hold function allows the operator to rinse the electrodes prior to recording actual measurement values
- Default hold time – 30 minutes

TCMP

for pH/ORP

Set the temperature compensation parameters for pH/ORP (menu option available for analyzers with a pH/ORP board installed):

- Enable or disable the ATC probe measurements
 - Scroll between On or OFF
 - Default setting – On
- If the ATC probe measurements are disabled, manually set the solution temperature value
 - Set the solution temperature from -10.0 °C to 110.0 °C
- Set the solution temperature compensation type
 - Scroll through OFF, t (treated), UP (ultrapure) and USr (operator entered value)
 - The treated solution temperature compensation value is -0.032 pH units per degree celsius
 - The ultrapure solution temperature compensation value is -0.016 pH units per degree celsius
 - The operator defined solution temperature compensation value can be set from -0.999 to 0.999 pH units per degree celsius

TCMP

for conductivity

Set the temperature compensation parameters for conductivity (menu option available for analyzers with a conductivity board installed):

- Set the temperature compensation type
 - Scroll through OFF, LIn (linear), nLF (nonlinear for natural waters), nACL (NaCl for ultrapure water with traces of sodium chloride), HCL (HCl for ultrapure water with traces of hydrochloric acid) and nH3 (NH₃ for ultrapure water with traces of ammonia)
- Set the linear temperature compensation value if LIn was selected as the temperature compensation type
 - The operator defined linear temperature compensation value can be set from 0.00 to 10.00 percent per degree celsius

TADJ

Adjust the temperature reading from the ATC probe by ± 5.0 °C:

- Default adjustment – 0.0 °C

ALRM

Set up to three alarms – high, low and an error signaling contact:

- Relays 1 and 2 (rLY1, rLY2) are normally open dry contacts used to set high and low alarms for measurement values
 - rLY1 and rLY2 options – OFF, HI, LO
- Relay 3 (rLY3) is normally a closed contact that can be dedicated to errors (will close if power to analyzer is lost), this alarm is influenced by calibration, errors and offline or hold status
 - rLY3 options – OFF, CAL, HOLD, Err
- Default setting for all alarms – OFF

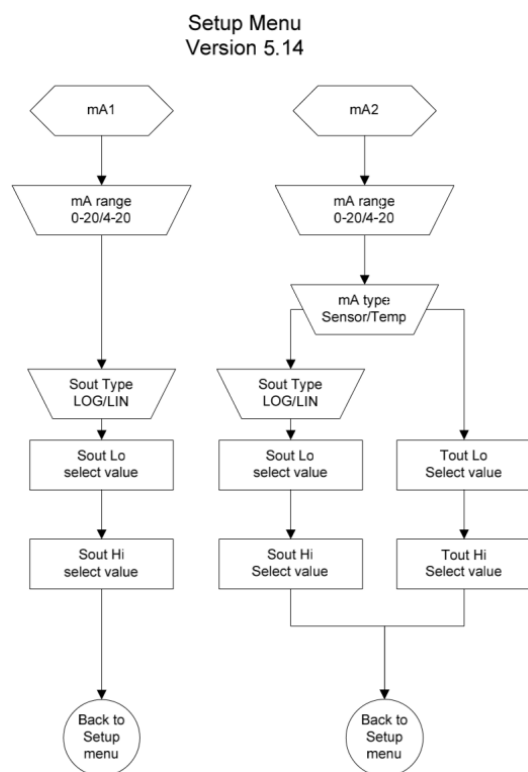

mA1

Set the mA1 analog current output:

- Scroll between 4-20 mA or 0-20 mA current signals
 - The outputs share a common return, but are isolated from the main circuitry of the analyzer
 - Default output current: 4-20 mA

- Scroll between logarithmic (LOg) and linear (LIn) scale.
- Set the low and high limits for the sensor output (SOUT)
- Default – 1.0 ppb (low) and 100 ppb (high)

mA2

Set the mA2 analog current output:

- Scroll between 4-20 mA or 0-20 mA current signals
 - The outputs share a common return, but are isolated from the main circuitry of the analyzer
 - Default output current: 4-20 mA

Select Sensor or Temperature for this output (SEnS and tEnP)

If Sense -

- Scroll between logarithmic (LOg) and linear (LIn) scale for SOUT
- Set the low and high limits for the sensor output (SOUT)
 - Default – 1.0 ppb (low) and 100 ppb (high)

If Temp -

- Set the low and high limits for the temperature output (tOUT)
 - Default – 5.0 °C (low) and 45.0 °C (high)

mADJ

Set the mA offset adjustment value for mA1 and mA2 outputs:

- Select OUT1 or OUT2 output
- Scroll the numeric offset value and positive or negative offset value
 - Default mA offset – 00.0 mA

TEST

Test relays and analog output lines (DIAGNOSTICS will appear in the mode indicator):

- Method to activate/deactivate relays and outputs to be tested
- Verify the accuracy of the analog outputs when used with an external loop calibrator
- Provides the values and settings for the mA output and relays
- mA output
 - 4-20
 - The low and high values represented by mA1 and mA2
- Relay status
 - Set RLY1, RLY2 and RLY3 status to OFF or On

CAL

Set calibration frequency in hours:

- High limit is 19999 hours
- Low limit is 00000 hours
- Default setting – 720 hours

PH

for pH/ORP

Select the buffer set that will be used for automatic buffer recognition during a pH calibration:



- US – pH 1.68, 4.01, 7.00, 10.01, 12.46 buffers
- EUrO – pH 1.68, 4.01, 6.86, 9.18 buffers
- Default buffer set – US

















COND





for conductivity

Set the nominal cell constant value of the conductivity probe for automatic cell constant adjustment during a conductivity calibration:

- Set the value from 0.001 cm⁻¹ to 199.9 cm⁻¹
- The Thermo Scientific Orion 2002CC conductivity probe has a nominal cell constant of 0.475 cm⁻¹ and the Thermo Scientific Orion 2002SS conductivity probe has a nominal cell constant of 0.1 cm⁻¹
- Default nominal cell constant value – 0.100 cm⁻¹









Default	Operator Action	Scrolling Marquee	Main Display	Notes
SETUP (One Channel Analyzer)				
	Press  to enter setup mode <ul style="list-style-type: none"> • SETUP appears as the mode indicator in the mode window • HOLD is displayed while in the setup mode • The system will enter the setup mode at the last saved menu option 	PASS DATE TIME LOG RSET DISP MDL MEAS HOLD TCMP TADJ ALRM mA1 mA2 mADJ TEST CAL PH COND	SEL SCm	Not all of the menu options will be displayed. The displayed menu options depend on the measurement capability of the analyzer.
	Press  to loop through the menu options			
	Press  to select the desired menu option and enter the submenu to customize setup parameters			

Default	Operator Action	Scrolling Marquee	Main Display	Notes
	PASS	PASS (flashing)	SEL SCrn	
	Press  to set new passwords			
0 0 0 0		SET-UP NEW SYSTEM PASSWORD	PASS # # # # (first digit flashing)	
	Press  /  to set the first digit Press  to move to the next digit Press  /  to set the values of the remaining digits and press  to move through the remaining digits	SET-UP NEW SYSTEM PASSWORD	PASS # # # # (change flashing digit)	Do not scroll first digit above 9
	Press  to accept the system password and advance to the next screen to set the calibration password			
0 0 0 0		SET-UP NEW CALIBRATION PASSWORD	PASS # # # # (first digit flashing)	
	Press  /  to set the first digit Press  to move to the next digit Press  /  to set the values of the remaining digits and press  to move through the remaining digits	SET-UP NEW CALIBRATION PASSWORD	PASS # # # # (change flashing digit)	Do not scroll first digit above 9
	Press  to accept the calibration password and return to the main setup mode			
		PASS (flashing)	SEL SCrn	
	Press  to scroll to the next menu			

Default	Operator Action	Scrolling Marquee	Main Display	Notes
	DATE	DATE (flashing)	SEL SCrn	
	Press  to set the date			
US		SET USA OR EUROPEAN	US (flashing)	
	Press  /  to scroll between US and EUrO	SET USA OR EUROPEAN	US or EUrO (flashing)	
	Press  to accept the setting and advance to the next screen			







Default	Operator Action	Scrolling Marquee	Main Display	Notes
01/01/ 2000		ENTER DATE MM/DD/YYYY (US) or ENTER DATE DD/MM/YYYY (EUrO)	## . ## (Month . Day) 2 0 ## (Year) or ## . ## (Day . Month) 2 0 ## (Year) (first digit flashing)	
	Press / to set the first digit Press to move to the next digit Press / to set the values of the remaining digits and press to move through the remaining digits	ENTER DATE MM/DD/YYYY (US) or ENTER DATE DD/MM/YYYY (EUrO)	## . ## (Month . Day) 2 0 ## (Year) or ## . ## (Day . Month) 2 0 ## (Year) (change flashing digit)	
	Press to accept the date setting and return to the main setup mode			
		DATE (flashing)	SEL SCrn	
	Press to scroll to the next menu			

Default	Operator Action	Scrolling Marquee	Main Display	Notes
	TIME	TIME (flashing)	SEL SCrn	
	Press to set the time			
00:01		ENTER 24HR TIME HOUR/MINUTE	## : ## (hour : minute) (first digit flashing)	
	Press / to set the first digit Press to move to the next digit Press / to set the values of the remaining digits and press to move through the remaining digits	ENTER 24HR TIME HOUR/MINUTE	## : ## (hour : minute) (change flashing digit)	Set in 24 hour time format
	Press to accept the time setting and return to the main setup mode			
		TIME (flashing)	SEL SCrn	
	Press to scroll to the next menu			

Default	Operator Action	Scrolling Marquee	Main Display	Notes
	LOG	LOG (flashing)	SEL SCrn	
	Press  to set the log interval			
00:00		SET LOG TIME IN HOUR/MINUTE	## : ## (hour : minute) LOg (first digit flashing)	
	Press  /  to set the first digit Press  to move to the next digit Press  /  to set the values of the remaining digits and press  to move through the remaining digits	SET LOG TIME IN HOUR/MINUTE	# # : # # (hour : minute) LOg (change flashing digit)	To disable the log enter 0000 for the log interval The minimum log interval is 1 minute and the maximum log interval is 99 hours and 59 minutes
	Press  to accept the log setting and return to the main setup mode			
		LOG (flashing)	SEL SCrn	
	Press  to scroll to the next menu			



WARNING: The reset command will erase all operator settings, logs and calibration data. The analyzer will need to be set up and calibrated again before it can resume operation.

Default	Operator Action	Scrolling Marquee	Main Display	Notes
	RSET	RSET (flashing)	SEL SCrn	
	Press  to reset the analyzer			
		PUSH TEST VIEW ENTER TO RESET	rSet ?	
	To Reset the Analyzer:			
	Press  Press  Press  When the reset is complete, the system will return to the measure mode. The operator will need to re-enter the setup mode to continue programming the setup parameters. Press  to return to the setup mode.	PUSH TEST VIEW ENTER TO RESET	rSet ?	This command resets all previously set parameters to factory default values. Use this command only to set the analyzer to original factory setup values.
	To Abort the Reset:			
	Press  to return to the main setup mode	PRESS TEST VIEW ENTER TO RESET	rSet ?	
		RSET (flashing)	SEL SCrn	
	Press  to scroll to the next menu			







WARNING: Resetting the analyzer will erase all stored information including relay, logs and calibration settings.







Default	Operator Action	Scrolling Marquee	Main Display	Notes
	DISP	DISP (flashing)	SEL SCrn	
	Press to set the lighting option for the backlit display			
AUtO		BACK LITE	LITE AUtO (flashing)	
	Press / to scroll through AUtO, OFF and On settings	BACK LITE	LITE AUtO, OFF or On (flashing)	
	Press to accept the display setting and return to the main setup mode			
		DISP (flashing)	SEL SCrn	
	Press to scroll to the next menu			

Note: The following menu options are for analyzers with two modules installed only. If two channels are used, select the channel number in the main setup mode (CH1 or CH2) and additional menu options will be displayed.

















Default	Operator Action	Scrolling Marquee	Main Display	Notes
	CH1	CH1 (flashing)	SEL SCrn	CH1 will not be shown in scrolling marquee if only one board is installed
	Press to set the channel 1 specific menus in the setup mode			
	Press to loop through the channel specific menu options	MDL (flashing)	SEL CH1	
	Press to select a menu option and customize the parameter (refer to the menu option displays that are shown on the following pages for detailed instructions)			
		CH1 (flashing)	SEL SCrn	
	Press to scroll to the next menu			

Default	Operator Action	Scrolling Marquee	Main Display	Notes
	CH2	CH2 (flashing)	SEL SCrn	CH2 will not be shown in scrolling marquee if only one board is installed
	Press  to set the channel 2 specific menus in the setup mode			
	Press  to loop through the channel specific menu options	MDL (flashing)	SEL CH2	
	Press  to select a menu option and customize the parameter (refer to the menu option displays that are shown on the following pages for detailed instructions)			
		CH2 (flashing)	SEL SCrn	
	Press  to scroll to the next menu			



















Note: The following menu option is for analyzers with a pH/ORP module installed only.

Default	Operator Action	Scrolling Marquee	Main Display	Notes
	MDL	MDL (flashing)	SEL SCrn	SEL CH1 or SEL CH2 on main display of two channel analyzer
	Press  to set the measurement parameter for the analyzer			
PH		SELECT PH OR ORP	PH (flashing)	
	Press  /  to scroll between PH and OrP and select the desired measurement parameter	SELECT PH OR ORP	PH or OrP (flashing)	
	Press  to accept the measurement setting and return to the main setup mode			
		CH1 or CH2 (flashing)	SEL SCrn	Displayed for two channel analyzer
	Press  to return to the channel specific menu options in the setup mode			Action required for two channel analyzer
		MDL (flashing)	SEL SCrn	SEL CH1 or SEL CH2 on main display of two channel analyzer
	Press  to scroll to the next menu			





















Note: The following menu option is for analyzers with a conductivity module installed only.



Default	Operator Action	Scrolling Marquee	Main Display	Notes
	MDL	MDL (flashing)	SEL SCrM	SEL CH1 or SEL CH2 on main display of two channel analyzer
	Press  to set the measurement parameters for the analyzer			
COnd		SELECT CONDUCTIVITY RESISTIVITY SALINITY CONCENTRATION OR TDS	dSPY COnd (flashing)	
	Press  /  to scroll through COnd, rES, SAL, COnC and tdS and select the desired measurement parameter	SELECT CONDUCTIVITY RESISTIVITY SALINITY CONCENTRATION OR TDS	dSPY COnd, rES, SAL, COnC or tdS (flashing)	
	Press  to accept the measurement setting and advance to the next screen			
nACL		SELECT CONCENTRATION TYPE NACL HCL NAOH H2SO4 AND HNO3	COnC nACL (flashing)	Displayed if COnC was selected in previous screen
	Press  /  to scroll through nACL, HCL, nAOH, H2SO and HnO3 and select the desired concentration display	SELECT CONCENTRATION TYPE NACL HCL NAOH H2SO4 AND HNO3	COnC nACL, HCL, nAOH, H2SO or HnO3 (flashing)	Action required if COnC was selected in previous screen
	Press  to accept the concentration display and advance to the next screen			Action required if COnC was selected in previous screen
00.42		SET TDS FACTOR	tdS ##.## (first digit flashing)	Displayed if tdS was selected in previous screen
	Press  /  to set the first digit Press  to move to the next digit Press  /  to set the values of the remaining digits and press  to move through the remaining digits	SET TDS FACTOR	tdS ##.## (change flashing digit)	Action required if tdS was selected in previous screen
	Press  to accept the TDS factor setting and return to the main setup			Action required if tdS was selected in previous screen
		CH1 or CH2 (flashing)	SEL SCrM	Displayed for two channel analyzer
	Press  to return to the channel specific menu options in the setup mode			Action required for two channel analyzer
		MDL (flashing)	SEL SCrM	SEL CH1 or SEL CH2 on main display of two channel analyzer
	Press  to scroll to the next menu			

Note: The following menu option is for analyzers with a pH/ORP module installed only.













Default	Operator Action	Scrolling Marquee	Main Display	Notes
	MEAS	MEAS (flashing)	SEL SCm	SEL CH1 or SEL CH2 on main display of two channel analyzer
	Press  to set measure parameters			
OFF		SHOW MV ON SINGLE CHANNEL DISPLAY	OFF (flashing)	
	Press  /  to scroll between OFF and On	SHOW MV ON SINGLE CHANNEL DISPLAY	OFF or On (flashing)	
	Press  to accept the setting and advance to the next screen			
2		SELECT RESOLUTION 1 OR 2 DECIMAL POINTS	rES 2 (flashing)	
	Press  /  to scroll between 2 and 1 decimal point options	SELECT RESOLUTION 1 OR 2 DECIMAL POINTS	rES 2 or 1 (flashing)	
	Press  to accept the setting and advance to the next screen			
Stnd		SELECT FILTER ALGORITHM STANDARD OR ULTRAPURE WATER	Stnd (flashing)	
	Press  /  to scroll between Stnd and UP filter algorithm options	SELECT FILTER ALGORITHM STANDARD OR ULTRAPURE WATER	Stnd or UP (flashing)	
	Press  to accept the setting and advance to the next screen			
07.00		SET ISO POINT	# # . # # (first digit flashing)	
	Press  /  to set the first digit Press  to move to the next digit Press  /  to set the values of the remaining digits and press  to move through the remaining digits	SET ISO POINT	# # . # # (change flashing digit)	
	Press  to accept the setting and return to the main setup mode			
		CH1 or CH2 (flashing)	SEL SCm	Displayed for two channel analyzer
	Press  to return to the channel specific menu options in the setup mode			Action required for two channel analyzer











Default	Operator Action	Scrolling Marquee	Main Display	Notes
		MEAS (flashing)	SEL SCrM	SEL CH1 or SEL CH2 on main display of two channel analyzer
	Press  to scroll to the next menu			

Default	Operator Action	Scrolling Marquee	Main Display	Notes
	HOLD	HOLD (flashing)	SEL SCrM	SEL CH1 or SEL CH2 on main display of two channel analyzer
	Press  to set the hold time			
00:05		ENTER HOLD TIME HOUR/MINUTE	# # : # # (first digit flashing)	
	Press  /  to set the first digit Press  to move to the next digit Press  /  to set the values of the remaining digits and press  to move through the remaining digits	ENTER HOLD TIME HOUR/MINUTE	# # : # # (change flashing digit)	
	Press  to accept the setting and advance to the next screen			
LAST		ENTER HOLD STATE LAST OR USER VALUE	LAST (flashing)	
	Press  /  to scroll between LAST and USEr	ENTER HOLD STATE LAST OR USER VALUE	LAST or USEr (flashing)	
	Press  to accept the setting and advance to the next screen			
21.0		ENTER FIXED USE VALUE IN mA	# # . # (first digit flashing)	Displayed if USEr was selected in previous screen
	Press  /  to set the first digit Press  to move to the next digit Press  /  to set the values of the remaining digits and press  to move through the remaining digits	ENTER FIXED USER VALUE IN mA	# # . # (change flashing digit)	Action required if USEr was selected in previous screen
	Press  to accept the setting and advance to the next screen			Action required if USEr was selected in previous screen
OFF		HOLD TO 22mA WHEN ERROR	OFF (flashing)	
	Press  /  to scroll between OFF and On	HOLD TO 22mA WHEN ERROR	OFF or On (flashing)	





Default	Operator Action	Scrolling Marquee	Main Display	Notes
	Press  to accept the setting and return to the main setup mode			
		CH1 or CH2 (flashing)	SEL SCrn	Displayed for two channel analyzer
	Press  to return to the channel specific menu options in the setup mode			Action required for two channel analyzer
		HOLD (flashing)	SEL SCrn	SEL CH1 or SEL CH2 on main display of two channel analyzer
	Press  to scroll to the next menu			









Note: The following menu option is for analyzers with a pH/ORP module installed only.











Default	Operator Action	Scrolling Marquee	Main Display	Notes
	TCMP	TCMP (flashing)	SEL SCrn	SEL CH1 or SEL CH2 on main display of two channel analyzer
	Press  to set temperature compensation parameters			
On		SET ATC MODE ON OR OFF	AtC On (flashing)	
	Press  /  to scroll between OFF and On	SET ATC MODE ON OR OFF	AtC On or OFF (flashing)	
	Press  to accept the setting and advance to the next screen			
25.0		SET MANUAL TEMPERATURE	##.## (first digit flashing)	Displayed if OFF was selected in previous screen
	Press  /  to set the first digit Press  to move to the next digit Press  /  to set the values of the remaining digits and press  to move through the remaining digits	SET MANUAL TEMPERATURE	##.## (change flashing digit)	Action required if OFF was selected in previous screen
	Press  to accept the setting and advance to the next screen			Action required if OFF was selected in previous screen
OFF		SET SOLUTION TEMP COMP OFF TREATED 032 ULTRA PURE 016 OR USER	SOL OFF (flashing)	
	Press  /  to scroll through OFF, t (treated), UP (ultrapure) and USr options	SET SOLUTION TEMP COMP OFF TREATED 032 ULTRA PURE 016 OR USER	SOL OFF, t, UP or USr (flashing)	





















Default	Operator Action	Scrolling Marquee	Main Display	Notes
	Press  to accept the setting and advance to the next screen			
0.000		SET COMP VALUE PER DEGREE C	# . # # # (first digit flashing)	Displayed if USr was selected in previous screen
	Press  /  to set the first digit Press  to move to the next digit Press  /  to set the values of the remaining digits and press  to move through the remaining digits	SET COMP VALUE PER DEGREE C	# . # # # (change flashing digit)	Action required if USr was selected in previous screen
	Press  to accept the setting and return to the main setup mode			
		CH1 or CH2 (flashing)	SEL SCrn	Displayed for two channel analyzer
	Press  to return to the channel specific menu options in the setup mode			Action required for two channel analyzer
		TCMP (flashing)	SEL SCrn	SEL CH1 or SEL CH2 on main display of two channel analyzer
	Press  to scroll to the next menu			

Note: The following menu option is for analyzers with a conductivity module installed only.

Default	Operator Action	Scrolling Marquee	Main Display	Notes
		TCMP (flashing)	SEL SCrn	SEL CH1 or SEL CH2 on main display of two channel analyzer
	Press  to set temperature compensation parameters			
OFF		SET TEMP COMP OFF LIN NLF NA CL HCL NH3	tC OFF (flashing)	
	Press  /  to scroll through OFF, LIn, nLF, nACL, HCL and nH ₃	SET TEMP COMP OFF LIN NLF NA CL HCL NH3	tC OFF, LIn, nLF, nACL, HCL or nH3 (flashing)	
	Press  to accept the setting and return to the main setup mode or advance to the next screen			
02.00		SET LIN TEMP COEF	tC # # . # # (first digit flashing)	Displayed if LIn was selected in previous screen

Default	Operator Action	Scrolling Marquee	Main Display	Notes
	Press  /  to set the first digit Press  to move to the next digit Press  /  to set the values of the remaining digits and press  to move through the remaining digits	SET LIN TEMP COEF	iC ##.## (change flashing digit)	Action required if LIn was selected in previous screen
	Press  to accept the setting and return to the main setup mode			
		CH1 or CH2 (flashing)	SEL SCm	Displayed for two channel analyzer
	Press  to return to the channel specific menu options in the setup mode			Action required for two channel analyzer
		TCMP (flashing)	SEL SCm	SEL CH1 or SEL CH2 on main display of two channel analyzer
	Press  to scroll to the next menu			











Default	Operator Action	Scrolling Marquee	Main Display	Notes
	TADJ	TADJ (flashing)	SEL SCm	SEL CH1 or SEL CH2 on main display of two channel analyzer
	Press  to set the temperature adjustment value			
0.0 C		TEMPERATURE ADJUSTMENT	Adj #. # c (first digit flashing)	
	Press  /  to set the first digit Press  to move to the next digit Press  /  to set the values of the next digit	TEMPERATURE ADJUSTMENT	Adj #. # c (change flashing digit)	The maximum temperature adjustment is ± 5.0 °C
	Press  to set a positive or negative temperature value	TEMPERATURE ADJUSTMENT	Adj _# . # c	
	Press  to accept the setting and return to the main setup mode			
		CH1 or CH2 (flashing)	SEL SCm	Displayed for two channel analyzer
	Press  to return to the channel specific menu options in the setup mode			Action required for two channel analyzer
		TADJ (flashing)	SEL SCm	SEL CH1 or SEL CH2 on main display of two channel analyzer
	Press  to scroll to the next menu			

Default	Operator Action	Scrolling Marquee	Main Display	Notes
	ALRM	ALRM (flashing)	SEL SCrn	SEL CH1 or SEL CH2 on main display of two channel analyzer
	Press  to set the alarms			
OFF		SELECT ALARM 1 HIGH LOW OR OFF	rLY1 OFF (flashing)	
	Press  /  to scroll through OFF, HI and LO	SELECT ALARM 1 HIGH LOW OR OFF	rLY1 OFF, HI or LO (flashing)	
	Press  to accept the setting and advance to the next screen			
07.00 pH or 0100 µS/cm	Set the HI or LO value for rLY1: Press  /  to set the first digit Press  to move to the next digit Press  /  to set the values of the remaining digits and press  to move through the remaining digits	ENTER VALUE	rLY1 ##.## (change flashing digit)	Displayed if HI or LO was selected for rLY1 in previous screen
	Press  to accept the setting and advance to the next screen			Action required if HI or LO was selected for rLY1 in previous screen
OFF		SELECT ALARM 2 HIGH LOW OR OFF	rLY2 OFF (flashing)	
	Press  /  to scroll through OFF, HI and LO	SELECT ALARM 2 HIGH LOW OR OFF	rLY2 OFF, HI or LO (flashing)	
	Press  to accept the setting and advance to the next screen			
07.00 pH or 0100 µS/cm	Set the HI or LO value for rLY2: Press  /  to set the first digit Press  to move to the next digit Press  /  to set the values of the remaining digits and press  to move through the remaining digits	ENTER VALUE	rLY2 ##.## (change flashing digit)	Displayed if HI or LO was selected for rLY2 in previous screen
	Press  to accept the setting and advance to the next screen			Action required if HI or LO was selected for rLY2 in previous screen
OFF		SELECT CALIBRATION HOLD ERROR OR OFF	rLY3 OFF (flashing)	









Default	Operator Action	Scrolling Marquee	Main Display	Notes
	Press / to scroll through OFF, CAL, HOLD and Err	SELECT CALIBRATION HOLD ERROR OR OFF	rLY3 OFF, CAL, HOLd or Err (flashing)	
	Press to accept the setting and return to the main setup mode			
		CH1 or CH2 (flashing)	SEL SCrn	Displayed for two channel analyzer
	Press to return to the channel specific menu options in the setup mode			Action required for two channel analyzer
		ALRM (flashing)	SEL SCrn	SEL CH1 or SEL CH2 on main display of two channel analyzer
	Press to scroll to the next menu			























Configuring the analog output mA1

















Default	Operator Action	Scrolling Marquee	Main Display	Notes
	mA1	mA1 (flashing)	SEL SCrn	SEL CH1 or SEL CH2 on main display of two channel analyzer
	Press to set the analog output 1			
4-20	Press / to scroll between 4-20 and 0-20	SELECT 0-20 OR 4-20	4-20 or 0-20 (flashing)	
	Press to accept the setting and advance to the next screen			
LOg	Press / to scroll between LOg and LIn	SELECT LOG OR LINEAR OUTPUT	SOUT LOg or LIn (flashing)	
	Press to accept the setting and advance to the next screen			
1 ppb		mA SENSOR OUTPUT LOW VALUE	LO ###.# (first digit flashing)	
	Press to move the decimal point Press / to set the first digit Press to move to the next digit Press / to set the values of the remaining digits and press to move through the remaining digits	mA SENSOR OUTPUT LOW VALUE	LO ###.# (change flashing digit)	
	Press to accept the setting and advance to the next screen			





Default	Operator Action	Scrolling Marquee	Main Display	Notes
100 ppb		mA SENSOR OUTPUT HIGH VALUE	HI ###.# (first digit flashing)	
	Press  to move the decimal point Press  /  to set the first digit Press  to move to the next digit Press  /  to set the values of the remaining digits and press  to move through the remaining digits	mA SENSOR OUTPUT HIGH VALUE	HI ###.# (change flashing digit)	
	Press  to accept the setting and advance to the next screen			
		CH1 or CH2 (flashing)	SEL SCrn	Displayed for two channel analyzer
	Press  to return to the channel specific menu options in the setup mode			Action required for two channel analyzer
		mA1 (flashing)	SEL SCrn	SEL CH1 or SEL CH2 on main display of two channel analyzer
	Press  to scroll to the next menu			















Configuring the analog output mA2















Default	Operator Action	Scrolling Marquee	Main Display	Notes
	mA2	mA2 (flashing)	SEL SCrn	
	Press  to set the analog output 2			
4-20	Press  /  to scroll between 4-20 and 0-20	SELECT 0-20 OR 4-20	4-20 or 0-20 (flashing)	
	Press  to accept the setting and advance to the next screen			
		AOUT 2 SENSOR OR TEMPERATURE	SEnS (flashing)	
	If choosing Sensor:			
	Press  /  to scroll between SE nS or tEnP and select SE nS	AOUT 2 SENSOR OR TEMPERATURE	SE nS (flashing)	
	Press  to accept the setting and advance to the next screen			
LOg	Press  /  to scroll between LOg and LIn	SELECT LOG OR LINEAR OUTPUT	LOg or LIn (flashing)	



















Default	Operator Action	Scrolling Marquee	Main Display	Notes
	Press  to accept the setting and advance to the next screen			
1 ppb		mA SENSOR OUTPUT LOW VALUE	LO ###.# (first digit flashing)	
	Press  to move the decimal point Press  /  to set the first digit Press  to move to the next digit Press  /  to set the values of the remaining digits and press  to move through the remaining digits	mA SENSOR OUTPUT LOW VALUE	LO ##.# (change flashing digit)	
	Press  to accept the setting and advance to the next screen			
100 ppb		mA SENSOR OUTPUT HIGH VALUE	HI ###.# (first digit flashing)	
	Press  to move the decimal point Press  /  to set the first digit Press  to move to the next digit Press  /  to set the values of the remaining digits and press  to move through the remaining digits	mA SENSOR OUTPUT HIGH VALUE	HI ##.# (change flashing digit)	
	Press  to accept the setting and advance to the next screen			
		CH1 or CH2 (flashing)	SEL SCrn	Displayed for two channel analyzer
	Press  to return to the channel specific menu options in the setup mode			Action required for two channel analyzer
		mA2 (flashing)	SEL SCrn	SEL CH1 or SEL CH2 on main display of two channel analyzer
	Press  to scroll to the next menu			
	If choosing temperature:			
	Press  /  to scroll between SEnS or tEnP and select tEnP	AOUT 2 SENSOR OR TEMPERATURE	tEnP (flashing)	
	Press  to accept the setting and advance to the next screen			
05.0 C		mA TEMP OUTPUT LOW VALUE	LO ##.#c (first digit flashing)	



Default	Operator Action	Scrolling Marquee	Main Display	Notes
	Press  /  to set the first digit Press  to move to the next digit Press  /  to set the values of the remaining digits and press  to set a positive or negative temperature value	mA TEMP OUTPUT LOW VALUE	LO ## . # c (change flashing digit)	
	Press  to accept the setting and advance to the next screen			
45.0 C		mA TEMP OUTPUT HIGH VALUE	HI ## . # c (first digit flashing)	
	Press  /  to set the first digit Press  to move to the next digit Press  /  to set the values of the remaining digits and press  to move through the remaining digits	mA TEMP OUTPUT HIGH VALUE	HI ## . # c (change flashing digit)	
	Press  to accept the setting and return to the main setup mode			
		CH1 or CH2 (flashing)	SEL SCrn	Displayed for two channel analyzer
	Press  to return to the channel specific menu options in the setup mode			Action required for two channel analyzer
		mA2 (flashing)	SEL SCrn	SEL CH1 or SEL CH2 on main display of two channel analyzer
	Press  to scroll to the next menu			











Default	Operator Action	Scrolling Marquee	Main Display	Notes
	mADJ	mADJ (flashing)	SEL SCrn	SEL CH1 or SEL CH2 on main display of two channel analyzer
	Press  to set the sensor and temperature mA offset values			
		SELECT mA1 OR mA2 OUTPUT	OUT1 or OUT2 (flashing)	
	Press  /  to scroll between OUT1 or OUT2 and select OUT1	SELECT mA1 OR mA2 OUTPUT	OUT1 (flashing)	
	Press  to accept the setting and advance to the next screen			

Default	Operator Action	Scrolling Marquee	Main Display	Notes
0.00		mA1 OUTPUT ADJUSTMENT	AdJ 0 . 0 # (last flashing digit)	
	Press  /  to set the sensor mA offset value Press  to set a positive or negative sensor mA offset	mA1 OUTPUT ADJUSTMENT	AdJ 0 . 0 # (change flashing digit)	
	Press  to accept the setting and return to the main setup mode			
		CH1 or CH2 (flashing)	SEL SCrn	Displayed for two channel analyzer
	Press  to return to the channel specific menu options in the setup mode			Action required for two channel analyzer
		mADJ (flashing)	SEL SCrn	SEL CH1 or SEL CH2 on main display of two channel analyzer
	Press  to set the sensor and temperature mA offset values			
		SELECT mA1 OR mA2 OUTPUT	OUT1 or OUT2 (flashing)	
	Press  /  to scroll between OUT1 or OUT2 and select OUT2	SELECT mA1 OR mA2 OUTPUT	OUT2 (flashing)	
	Press  to accept the setting and advance to the next screen			
0.00		mA2 OUTPUT ADJUSTMENT	AdJ 0 . 0 # (last flashing digit)	
	Press  /  to set the temperature mA offset value Press  to set a positive or negative temperature mA offset	mA2 OUTPUT ADJUSTMENT	AdJ 0 . 0 # (change flashing digit)	
	Press  to accept the setting and return to the main setup mode			
		CH1 or CH2 (flashing)	SEL SCrn	Displayed for two channel analyzer
	Press  to return to the channel specific menu options in the setup mode			Action required for two channel analyzer
		mADJ (flashing)	SEL SCrn	SEL CH1 or SEL CH2 on main display of two channel analyzer
	Press  to scroll to the next menu			







Default	Operator Action	Scrolling Marquee	Main Display	Notes
	TEST	TEST (flashing)	SEL SCrn	SEL CH1 or SEL CH2 on main display of two channel analyzer
	Press  to test the mA outputs (4-20) and relays (rLY)			DIAGNOSTICS appears above SETUP in mode window
	To Test OUT2:			
4-20	Press  /  to scroll between 4-20 and rLY settings and select 4-20	SELECT mA OR RELAY	tEst 4 - 20 (flashing)	
	Press  to test 4-20 outputs			
		SELECT mA1 OR mA2 OUTPUT	4 - 20 OUT1 or OUT2 (flashing)	
	Press  /  to scroll between OUT1 and OUT2 settings and select OUT2	SELECT mA1 OR mA2 OUTPUT	4 - 20 OUT2 (flashing)	
	Press  to display the OUT2 low value			
Actual low value displayed		mA TEMP OUTPUT LOW VALUE	LO # . # c	4.0 mA are sourced at output terminal 11
	Press  to display the OUT2 high value			
Actual high value displayed		mA TEMP OUTPUT HIGH VALUE	HI # . # c	20.0 mA are sourced at output terminal 11
	Press  to accept the HI value and return to the main setup mode			
		CH1 or CH2 (flashing)	SEL SCrn	Display for two channel analyzer only
	Press  to return to the channel specific menu options in the setup mode			Action required for two channel analyzer only
		TEST (flashing)	SEL SCrn	SEL CH1 or SEL CH2 on main display of two channel analyzer
	Press  to test the mA outputs (4-20) and relays (rLY)			
	To Test mA1:			
4-20	Press  /  to scroll between 4-20 and rLY settings and select 4-20	SELECT mA OR RELAY	tEst 4 - 20 (flashing)	
	Press  to test 4-20 outputs			

Default	Operator Action	Scrolling Marquee	Main Display	Notes
		SELECT mA1 OR mA2 OUTPUT	4 - 20 OUT1 or OUT2 (flashing)	
	Press  /  to scroll between OUT1 and OUT2 settings and select OUT1	SELECT mA1 OR mA2 OUTPUT	4 - 20 OUT1 (flashing)	
	Press  to display the mA1 low value			
Actual low value displayed		mA SENSOR OUTPUT LOW VALUE	LO # . #	4.0 mA are sourced at output terminal 9
	Press  to display the mA1 high value			
Actual high value displayed		mA SENSOR OUTPUT HIGH VALUE	HI # . #	20.0 mA are sourced at output terminal 9
	Press  to accept the test and return to the main setup mode			
		CH1 or CH2 (flashing)	SEL SCm	Display for two channel analyzer only
	Press  to return to the channel specific menu options in the setup mode			Action required for two channel analyzer only
		TEST (flashing)	SEL SCm	SEL CH1 or SEL CH2 on main display of two channel analyzer
	Press  to test the mA outputs (4-20) and relays (rLY)			
	To Test rLY:			
4-20	Press  /  to scroll between 4-20 and rLY settings and select rLY	SELECT mA OR RELAY	tEst rLY (flashing)	
Actual rLY1 status	Press  to test relay outputs Press  /  to set the rLY1 setting OFF or On	USE ARROWS TO TOGGLE RELAY 1	rLY1 OFF or On	Relay contact according to screen indication
	Press  to accept the rLY1 test and move to the rLY2 test			
Actual rLY2 status	Press  /  to set the rLY2 setting OFF or On	USE ARROWS TO TOGGLE RELAY 2	rLY2 OFF or On	Relay contact according to screen indication
	Press  to accept the rLY2 test and move to the rLY3 test			
Actual rLY3 status	Press  /  to set the rLY3 setting OFF or On	USE ARROWS TO TOGGLE RELAY 3	rLY3 OFF or On	Relay contact according to screen indication











Default	Operator Action	Scrolling Marquee	Main Display	Notes
	Press  to accept the rLY3 test and return to the main setup mode			
		CH1 or CH2 (flashing)	SEL SCrn	Display for two channel analyzer only
	Press  to return to the channel specific menu options in the setup mode			Action required for two channel analyzer only
		TEST (flashing)	SEL SCrn	SEL CH1 or SEL CH2 on main display of two channel analyzer
	Press  to scroll to the next menu			

Default	Operator Action	Scrolling Marquee	Main Display	Notes
	CAL	CAL (flashing)	SEL SCrn	SEL CH1 or SEL CH2 on main display of two channel analyzer
	Press  to set the required calibration frequency			
0720		ENTER CALIBRATION FREQUENCY IN HOURS	CAL ### (first digit flashing)	To disable the calibration alarm, set the value to 0000
	Press  /  to set the first digit Press  to move to the next digit Press  /  to set the values of the remaining digits and press  to move through the remaining digits	ENTER CALIBRATION FREQUENCY IN HOURS	CAL ### (change flashing digit)	
	Press  to accept the setting and return to the main setup mode			
		CH1 or CH2 (flashing)	SEL SCrn	Displayed for two channel analyzer
	Press  to return to the channel specific menu options in the setup mode			Action required for two channel analyzer
		CAL (flashing)	SEL SCrn	SEL CH1 or SEL CH2 on main display of two channel analyzer
	Press  to scroll to the next menu			

Note: The following menu option is for analyzers with a pH/ORP module installed only.

Default	Operator Action	Scrolling Marquee	Main Display	Notes
	PH	PH (flashing)	SEL SCrn	SEL CH1 or SEL CH2 on main display of two channel analyzer
	Press  to set the pH buffer setting used for the electrode calibration			
US		SELECT BUFFER SET US OR EURO	Std US (flashing)	
	Press  /  to scroll between US and EUrO	SELECT BUFFER SET US OR EURO	Std US or EUrO (flashing)	
	Press  to accept the setting and return to the main setup mode			
		CH1 or CH2 (flashing)	SEL SCrn	Displayed for two channel analyzer
	Press  to return to the channel specific menu options in the setup mode			Action required for two channel analyzer
		PH (flashing)	SEL SCrn	SEL CH1 or SEL CH2 on main display of two channel analyzer
	Press  to scroll to the next menu			

Note: The following menu option is for analyzers with a conductivity board installed only.

Default	Operator Action	Scrolling Marquee	Main Display	Notes
	COND	COND (flashing)	SEL SCrn	SEL CH1 or SEL CH2 on main display of two channel analyzer
	Press  to set the conductivity cell constant setting used for the calibration			
0.100		SET NOMINAL CELL CONSTANT FOR AUTO-STANDARD RECOGNITION	CELL # . ### (first digit flashing)	
	Press  to move the decimal point Press  /  to set the first digit Press  to move to the next digit Press  /  to set the values of the remaining digits and press  to move through the remaining digits	SET NOMINAL CELL CONSTANT FOR AUTO-STANDARD RECOGNITION	CELL # . ### (change flashing digit)	
	Press  to accept the setting and return to the main setup mode			
		CH1 or CH2 (flashing)	SEL SCrn	Displayed for two channel analyzer
	Press  to return to the channel specific menu options in the setup mode			Action required for two channel analyzer
		COND (flashing)	SEL SCrn	SEL CH1 or SEL CH2 on main display of two channel analyzer
	Press  to scroll to the next menu			

4

SECTION 4 **Calibration**

Calibration Overview

The Thermo Scientific Orion 2100 series pH/ORP and conductivity analyzers provide simple and fast calibration cycles that quickly have your system back online with security and confidence.

Prior to performing a calibration, refer to Section 3, Use of the Setup Mode for instructions on how to properly configure the analyzer.

pH Calibration Setup

Maximum system accuracy is ensured by performing a fast and easy calibration in the expected sample pH range. Select one pH buffer that is closest to the expected sample pH or select two or three pH buffers that bracket the expected sample pH. Two or three pH buffers are recommended for the most accurate calibration.

pH Calibration Recommendations

- Prepare the pH electrode according to the instructions in the pH electrode user guide or instruction sheet.
- Always pour fresh pH buffers into clean beakers for calibration. If using more than one buffer, select buffers that are one to four pH units apart.

- The filling solution level inside of the electrode must be at least one inch above the buffer solution level during calibration.
- The buffer solution level must be above the pH electrode reference junction when the electrode is immersed in the buffer.
- Between buffers, rinse the electrode with distilled or de-ionized water and then with the next buffer. To reduce the chance of error due to polarization, avoid rubbing or wiping the electrode bulb. Use a lint-free tissue and gently blot the bulb.

pH Calibration Procedure

A one, two or three point calibration, using fresh pH buffers, should be performed before pH measurements are taken. It is recommended that a two or three point calibration be performed at least once per month to determine the slope of the electrode and to verify that the electrode is working properly. A one point calibration can be performed periodically to correct for electrode drift. Whenever a new electrode is installed, it must be calibrated before it can be used to perform accurate measurements.

For the best calibration results, the buffer conditions should be similar to the sample conditions. It is also recommended that an ATC probe be used during the calibration if an ATC probe is used in the sample and the sample measurements are being temperature compensated.

Automatic Buffer Recognition or Manual Calibration



















When performing a pH calibration, the operator must choose to use the automatic buffer recognition feature or perform a manual calibration. When using the automatic buffer recognition feature, the analyzer uses the mV readings of the pH electrode to automatically identify the pH buffer values during the calibration. When performing a manual calibration, the operator must enter the pH buffer values during the calibration.





When using the automatic buffer recognition feature, select the pH buffer set that will be used for the automatic buffer recognition feature in the setup mode (the US buffer set includes pH 1.68, 4.01, 7.00, 10.01 and 12.46 buffers and the EUrO buffer set includes pH 1.68, 4.01, 6.86 and 9.18 buffers).



















To use the automatic buffer recognition feature, the mV readings of the pH electrode must be in the ranges listed in the following table.

















Buffer	mV Range	Buffer	mV Range
1.68	+285 to +345	9.18	-99 to -159
4.01	+207 to +147	10.01	-207 to -147
6.86	+38 to -22	12.46	-293 to -353
7.00	- 30 to + 30		











The calibration parameters must be entered in the setup mode prior to performing a calibration. Refer to Section 3, Use of the Setup Mode and Section 4, pH Calibration Setup.

Step	Operator Action	Scrolling Marquee	Main Display	Notes
pH Calibration Procedure using the Automatic Buffer Recognition Feature				
1	Make sure that the analyzer is in the measure mode.	Actual temperature reading	Actual pH reading	
2	Press  to initiate the calibration.			CAL appears as mode
3	If the calibration password is active, enter the calibration password by pressing  /  to set the first digit,  to move to the next digit,  /  to set the values of the remaining digits and  to move through the remaining digits. Press  to accept the password.	ENTER PASSWORD	PASS ####	
4		CH1 or CH2 (flashing)	CAL CHnL	Displayed for two channel analyzer
5	Press  /  to select the channel that will be calibrated and press  to begin the calibration.	CH1 or CH2 (flashing)	CAL CHnL	Action required for two channel analyzer
6		SCROLL THE NUMBER OF POINTS FOR PH CALIBRATION	2Pt (flashing)	
7	Press  /  to scroll through two point (2Pt), three point (3Pt) or one point (1Pt) pH calibration options and press  to accept the setting.	SCROLL THE NUMBER OF POINTS FOR PH CALIBRATION	2Pt, 3Pt or 1Pt (flashing)	
8		SCROLL YES FOR AUTO BUFFER RECOGNITION OR NO FOR MANUAL	AUTO YES or nO (flashing)	
9	Press  /  to scroll between YES or nO, select YES and press  to accept the setting.	SCROLL YES FOR AUTO BUFFER RECOGNITION OR NO FOR MANUAL	AUTO YES (flashing)	
10		PLACE PROBE IN BUFFER NUM 1 PRESS ENTER	CAL Pt1	
11	Place the pH electrode into the first pH buffer and press  .	PLACE PROBE IN BUFFER NUM 1 PRESS ENTER	CAL Pt1	
12	Wait 0 to 5 minutes for the pH reading to stabilize. The system is continuously evaluating the data by applying a stability criteria until a stable condition is met.	AWAITING DATA STABILITY	Actual pH and mV readings flashing	

Step	Operator Action	Scrolling Marquee	Main Display	Notes
13		PLACE PROBE IN BUFFER NUM 2 PRESS ENTER	CAL Pt2	Steps 13 through 15 are required when 2Pt or 3Pt is selected as the number of calibration points.
14	Remove the pH electrode from the first pH buffer, rinse it with distilled water and blot it dry with a lint-free tissue. Place the pH electrode into the second pH buffer and press  .	PLACE PROBE IN BUFFER NUM 2 PRESS ENTER	CAL Pt2	
15	Wait 0 to 5 minutes for the pH reading to stabilize. The system is continuously evaluating the data by applying a stability criteria until a stable condition is met.	AWAITING DATA STABILITY	Actual pH and mV readings flashing	
16		PLACE PROBE IN BUFFER NUM 3 PRESS ENTER	CAL Pt3	Steps 16 through 18 are required when 3Pt is selected as the number of calibration points.
17	Remove the pH electrode from the second pH buffer, rinse it with distilled water and blot it dry with a lint-free tissue. Place the pH electrode into the third pH buffer and press  .	PLACE PROBE IN BUFFER NUM 3 PRESS ENTER	CAL Pt3	
18	Wait 0 to 5 minutes for the pH reading to stabilize. The system is continuously evaluating the data by applying a stability criteria until a stable condition is met.	AWAITING DATA STABILITY	Actual pH and mV readings flashing	
19	No operator action needed. The system calculates a new E_o and slope and checks for errors.			If there is calibration related error, the appropriate error message will be displayed.
20	Press  to accept the new slope and E_o values. or Press  to abort the calibration without saving the new slope and E_o values. The values for the last saved calibration prior to the aborted calibration will be used in the measure mode.	AVG SLOPE AND E_o PRESS ENTER TO ACCEPT OR PRESS EXIT TO ABORT	Calculated slope on first line and E_o on second line	
21	No operator action needed. The system will enter the measure mode and remain on hold until the hold timer expires (default hold time is 5 minutes).	Actual temperature reading	Actual pH reading	

Step	Operator Action	Scrolling Marquee	Main Display	Notes
pH Calibration Procedure using the Manual Calibration Feature				
1	Make sure that the analyzer is in the measure mode.	Actual temperature reading	Actual pH reading	
2	Press  to initiate the calibration.			CAL appears as mode
3	If the calibration password is active, enter the calibration password by pressing  /  to set the first digit,  to move to the next digit,  /  to set the values of the remaining digits and  to move through the remaining digits. Press  to accept the password.	ENTER PASSWORD	PASS ####	
4		CH1 or CH2 (flashing)	CAL CHnL	Displayed for two channel analyzer
5	Press  /  to select the channel that will be calibrated and press  to begin the calibration.	CH1 or CH2 (flashing)	CAL CHnL	Action required for two channel analyzer
6		SCROLL THE NUMBER OF POINTS FOR PH CALIBRATION	2Pt (flashing)	
7	Press  /  to scroll through two point (2Pt), three point (3Pt) or one point (1Pt) pH calibration options and press  to accept the setting.	SCROLL THE NUMBER OF POINTS FOR PH CALIBRATION	2Pt, 3Pt or 1Pt (flashing)	
8		SCROLL YES FOR AUTO BUFFER RECOGNITION OR NO FOR MANUAL	AUTO YES or nO (flashing)	
9	Press  /  to scroll between YES or nO, select nO and press  to accept the setting.	SCROLL YES FOR AUTO BUFFER RECOGNITION OR NO FOR MANUAL	AUTO nO (flashing)	
10		PLACE PROBE IN BUFFER NUM 1 PRESS ENTER	CAL Pt1	
11	Place the pH electrode into the first pH buffer and press  .	PLACE PROBE IN BUFFER NUM 1 PRESS ENTER	CAL Pt1	
12	Wait 0 to 5 minutes for the pH reading to stabilize. The system is continuously evaluating the data by applying a stability criteria until a stable condition is met.	AWAITING DATA STABILITY	Actual pH and mV readings flashing	
13		SCROLL BUFFER VALUE PRESS ENTER	##.## (first digit flashing)	

Step	Operator Action	Scrolling Marquee	Main Display	Notes
14	<p>Enter the pH value of the buffer at the measured temperature.</p> <p>Press  /  to set the first digit.</p> <p>Press  to move to the next digit.</p> <p>Press  /  to set the values of the remaining digits and press  to move through the remaining digits.</p> <p>Press  to move the decimal point.</p>	<p>SCROLL BUFFER VALUE</p> <p>PRESS ENTER</p>	<p>##.##</p> <p>(change digit flashing)</p>	
15	<p>Press  to accept the buffer value and advance to the next screen.</p>			
16		<p>PLACE PROBE IN BUFFER NUM 2</p> <p>PRESS ENTER</p>	<p>CAL</p> <p>Pt2</p>	Steps 16 through 21 are required when 2Pt or 3Pt is selected as the number of calibration points.
17	<p>Remove the pH electrode from the first pH buffer, rinse it with distilled water and blot it dry with a lint-free tissue.</p> <p>Place the pH electrode into the second pH buffer and press .</p>	<p>PLACE PROBE IN BUFFER NUM 2</p> <p>PRESS ENTER</p>	<p>CAL</p> <p>Pt2</p>	
18	<p>Wait 0 to 5 minutes for the pH reading to stabilize.</p> <p>The system is continuously evaluating the data by applying a stability criteria until a stable condition is met.</p>	<p>AWAITING DATA STABILITY</p>	<p>Actual pH and mV readings flashing</p>	
19		<p>SCROLL BUFFER VALUE</p> <p>PRESS ENTER</p>	<p>##.##</p> <p>(first digit flashing)</p>	
20	<p>Enter the pH value of the buffer at the measured temperature.</p> <p>Press  /  to set the first digit.</p> <p>Press  to move to the next digit.</p> <p>Press  /  to set the values of the remaining digits and press  to move through the remaining digits.</p> <p>Press  to move the decimal point.</p>	<p>SCROLL BUFFER VALUE</p> <p>PRESS ENTER</p>	<p>##.##</p> <p>(change digit flashing)</p>	
21	<p>Press  to accept the buffer value and advance to the next screen.</p>			
22		<p>PLACE PROBE IN BUFFER NUM 3</p> <p>PRESS ENTER</p>	<p>CAL</p> <p>Pt3</p>	Steps 22 through 27 are required when 3Pt is selected as the number of calibration points.









Step	Operator Action	Scrolling Marquee	Main Display	Notes
23	Remove the pH electrode from the second pH buffer, rinse it with distilled water and blot it dry with a lint-free tissue. Place the pH electrode into the third pH buffer and press  .	PLACE PROBE IN BUFFER NUM 3 PRESS ENTER	CAL Pt3	
24	Wait 0 to 5 minutes for the pH reading to stabilize. The system is continuously evaluating the data by applying a stability criteria until a stable condition is met.	AWAITING DATA STABILITY	Actual pH and mV readings flashing	
25		SCROLL BUFFER VALUE PRESS ENTER	##.## (first digit flashing)	
26	Enter the pH value of the buffer at the measured temperature. Press  /  to set the first digit. Press  to move to the next digit. Press  /  to set the values of the remaining digits and press  to move through the remaining digits. Press  to move the decimal point.	SCROLL BUFFER VALUE PRESS ENTER	##.## (change digit flashing)	
27	Press  to accept the buffer value and advance to the next screen.			
28	No operator action needed. The system calculates a new E_0 and slope and checks for errors.			If there is calibration related error, the appropriate error message will be displayed.
29	Press  to accept the new slope and E_0 values. or Press  to abort the calibration without saving the new slope and E_0 values. The values for the last saved calibration prior to the aborted calibration will be used in the measure mode.	AVG SLOPE AND E_0 PRESS ENTER TO ACCEPT OR PRESS EXIT TO ABORT	Calculated slope on first line and E_0 on second line	
30	No operator action needed. The system will enter the measure mode and remain on hold until the hold timer expires (default hold time is 5 minutes).	Actual temperature reading	Actual pH reading	









ORP Calibration Setup























Maximum system accuracy is ensured by performing a fast and easy calibration in the expected sample mV range. ORP readings can be measured using the relative mV value or E_H mV value of the sample, depending on the preferred reporting method of the operator. The relative mV value is a calibrated mV measurement that provides standardized mV readings among many ORP electrodes. The E_H mV value is a calibrated mV measurement that provides the mV readings corresponding to what would be obtained using a Standard Hydrogen Electrode (SHE), also known as a Normal Hydrogen Electrode (NHE). ORP standard allows operators to calibrate their ORP measurements to the Standard Hydrogen Electrode if they are using a Thermo Scientific Orion ORP electrode and Thermo Scientific Orion ORP standard (Cat. No. 967961 and 967901). The operator must either use an automatic temperature compensation (ATC) probe or set the sample temperature value in the setup mode.



ORP Calibration Recommendations

- Prepare the ORP electrode according to the instructions in the ORP electrode user guide or instruction sheet.
- Always pour fresh ORP standard into a clean beaker for calibration.
- The filling solution level inside of the electrode must be at least one inch above the standard solution level during calibration.
- The standard solution level must be above the ORP electrode reference junction when the electrode is immersed in the standard.
- Before calibration, rinse the electrode with distilled or de-ionized water and then with the ORP standard. To reduce the chance of error due to polarization, avoid rubbing or wiping the measuring element. Use a lint-free tissue and gently blot the measuring element.

Step	Operator Action	Scrolling Marquee	Main Display	Notes
ORP Calibration Procedure using the E_H Calibration Feature				
1	Make sure that the analyzer is in the measure mode.	Actual temperature reading	Actual ORP reading	
2	Press  to initiate the calibration.			CAL appears as mode
3	If the calibration password is active, enter the calibration password by pressing  /  to set the first digit,  to move to the next digit,  /  to set the values of the remaining digits and  to move through the remaining digits. Press  to accept the password.	ENTER PASSWORD	PASS ####	

Step	Operator Action	Scrolling Marquee	Main Display	Notes
4		CH1 or CH2 (flashing)	CAL CHnL	Displayed for two channel analyzer
5	Press  /  to select the channel that will be calibrated and press  to begin the calibration.	CH1 or CH2 (flashing)	CAL CHnL	Action required for two channel analyzer
6		SCROLL YES FOR EH OR NO FOR MANUAL	EH YES or nO (flashing)	
7	Press  /  to scroll between YES or nO, select YES and press  to accept the setting.	SCROLL YES FOR EH OR NO FOR MANUAL	EH YES (flashing)	
8		PLACE PROBE IN STANDARD PRESS ENTER	CAL	
9	Place the ORP electrode into the ORP standard and press  .	PLACE PROBE IN STANDARD PRESS ENTER	CAL	
10	Wait 0 to 5 minutes for the mV reading to stabilize. The system is continuously evaluating the data by applying a stability criteria until a stable condition is met.	AWAITING DATA STABILITY	Actual relative mV and mV readings flashing	
11	No operator action needed. The system calculates a new mV offset and checks for errors.	ORP OFFSET PRESS ENTER TO ACCEPT OR PRESS EXIT TO ABORT	Calculated mV offset on second line	If there is calibration related error, the appropriate error message will be displayed.
12	Press  to accept the new mV offset. or Press  to abort the calibration without saving the new mV offset value. The value for the last saved calibration prior to the aborted calibration will be used in the measure mode.	ORP OFFSET PRESS ENTER TO ACCEPT OR PRESS EXIT TO ABORT	Calculated mV offset on second line	
13	No operator action needed. The system will enter the measure mode and remain on hold until the hold timer expires (default hold time is 5 minutes).	Actual temperature reading	Actual ORP reading	

Step	Operator Action	Scrolling Marquee	Main Display	Notes
ORP Calibration Procedure using the Manual Calibration Feature				
1	Make sure that the analyzer is in the measure mode.	Actual temperature reading	Actual ORP reading	
2	Press  to initiate the calibration.			CAL appears as mode
3	If the calibration password is active, enter the calibration password by pressing  /  to set the first digit,  to move to the next digit,  /  to set the values of the remaining digits and  to move through the remaining digits. Press  to accept the password.	ENTER PASSWORD	PASS ####	
4		CH1 or CH2 (flashing)	CAL CHnL	Displayed for two channel analyzer
5	Press  /  to select the channel that will be calibrated and press  to begin the calibration.	CH1 or CH2 (flashing)	CAL CHnL	Action required for two channel analyzer
6		SCROLL YES FOR EH OR NO FOR MANUAL	EH YES or nO (flashing)	
7	Press  /  to scroll between YES or nO, select nO and press  to accept the setting.	SCROLL YES FOR EH OR NO FOR MANUAL	EH nO (flashing)	
8		PLACE PROBE IN STANDARD PRESS ENTER	CAL	
9	Place the ORP electrode into the ORP standard and press  .	PLACE PROBE IN STANDARD PRESS ENTER	CAL	
10	Wait 0 to 5 minutes for the mV reading to stabilize. The system is continuously evaluating the data by applying a stability criteria until a stable condition is met.	AWAITING DATA STABILITY	Actual relative mV and mV readings flashing	
11		ENTER ORP STANDARD VALUE	###. # mV (first digit flashing)	
12	Enter the value of the ORP standard at the measured temperature. Press  /  to set the first digit. Press  to move to the next digit. Press  /  to set the values of the remaining digits and press  to move through the remaining digits. Press  to move the decimal point.	ENTER ORP STANDARD VALUE	###. # mV (change digit flashing)	
13	Press  to accept the ORP value and advance to the next screen.			

Step	Operator Action	Scrolling Marquee	Main Display	Notes
14	No operator action needed. The system calculates a new mV offset and checks for errors.	ORP OFFSET PRESS ENTER TO ACCEPT OR PRESS EXIT TO ABORT	Calculated mV offset on second line	If there is calibration related error, the appropriate error message will be displayed.
15	Press  to accept the new mV offset. or Press  to abort the calibration without saving the new mV offset value. The value for the last saved calibration prior to the aborted calibration will be used in the measure mode.	ORP OFFSET PRESS ENTER TO ACCEPT OR PRESS EXIT TO ABORT	Calculated mV offset on second line	
16	No operator action needed. The system will enter the measure mode and remain on hold until the hold timer expires (default hold time is 5 minutes).	Actual temperature reading	Actual ORP reading	

Conductivity Calibration Setup

Maximum system accuracy is ensured by performing a fast and easy calibration in the expected sample conductivity range. Select one conductivity standard that is closest to the expected sample conductivity or select two or three conductivity standards that bracket the expected sample conductivity.

Automatic Calibration, Direct Calibration or Manual Calibration

















An automatic calibration is performed by entering the nominal cell constant in the setup mode prior to calibration, immersing the conductivity probe in a conductivity standard and initiating the calibration. When the reading stabilizes, the analyzer displays the calibration standard value at 25 °C. Once the calibration is accepted, the analyzer calculates and displays the actual cell constant. The analyzer is capable of automatically recognizing 100 µS/cm, 1413 µS/cm and 12.9 mS/cm conductivity standards when the nominal cell constant of the conductivity probe is entered in the setup mode. For the analyzer to recognize the conductivity standard, enter the nominal cell constant of the conductivity probe that is attached to the analyzer (usually 0.1 cm⁻¹, 0.475 cm⁻¹ or 1.0 cm⁻¹).







A direct calibration is performed by immersing the conductivity probe in a calibration standard and then entering the conductivity standard value at the measured temperature so the correct cell constant value is displayed. A direct calibration requires a chart of the calibration standard values at different temperatures or the calibration can be performed with the calibration standard at 25 °C.



A manual calibration is performed by immersing the conductivity probe in a calibration standard and then entering the cell constant value so the correct conductivity standard value at the measured temperature is displayed. A manual calibration requires a chart of the calibration standard values at different temperatures or the calibration can be performed with the calibration standard at 25 °C.











Conductivity Calibration Recommendations



















- Prepare the conductivity probe according to the instructions in the conductivity probe user guide or instruction sheet.
- Always pour fresh conductivity standards into clean beakers for calibration. If using more than one conductivity standard, select conductivity standards that bracket the expected sample conductivity.
- The conductivity probe must be placed in the conductivity standard so the measuring electrodes and temperature sensor are fully immersed in the conductivity standard.
- Between conductivity standards, rinse the probe with distilled or de-ionized water and then with the next conductivity standard. To reduce the chance of error due to polarization, avoid rubbing or wiping the measuring electrodes. Use a lint-free tissue and gently blot the probe.











Step	Operator Action	Scrolling Marquee	Main Display	Notes
Conductivity Calibration Procedure using the Automatic Calibration Feature				
1	Make sure that the analyzer is in the measure mode.	Actual temperature reading	Actual conductivity reading	
2	Press  to initiate the calibration.			CAL appears as mode
3	If the calibration password is active, enter the calibration password by pressing  /  to set the first digit,  to move to the next digit,  /  to set the values of the remaining digits and  to move through the remaining digits. Press  to accept the password.	ENTER PASSWORD	PASS ####	
4		CH1 or CH2 (flashing)	CAL CHnL	Displayed for two channel analyzer
5	Press  /  to select the channel that will be calibrated and press  to begin the calibration.	CH1 or CH2 (flashing)	CAL CHnL	Action required for two channel analyzer
6		SELECT ENTERING CELL CONSTANT OR USING STANDARDS	Stnd or CELL (flashing)	
7	Press  /  to scroll between Stnd or CELL, select Stnd and press  to accept the setting.	SELECT ENTERING CELL CONSTANT OR USING STANDARDS	Stnd (flashing)	
8		SCROLL THE NUMBER OF POINTS FOR CONDUCTIVITY CALIBRATION	2Pt, 3Pt or 1Pt (flashing)	
9	Press  /  to scroll through two point (2Pt), three point (3Pt) or one point (1Pt) conductivity calibration options and press  to accept the setting.	SCROLL THE NUMBER OF POINTS FOR CONDUCTIVITY CALIBRATION	2Pt, 3Pt or 1Pt (flashing)	











Step	Operator Action	Scrolling Marquee	Main Display	Notes
10		SCROLL YES FOR AUTO STANDARD RECOGNITION OR NO FOR MANUAL	AUTO YES or nO (flashing)	
11	Press  /  to scroll between YES or nO, select YES and press  to accept the setting.	SCROLL YES FOR AUTO STANDARD RECOGNITION OR NO FOR MANUAL	AUTO YES (flashing)	
12		PLACE PROBE IN STANDARD NUM 1 PRESS ENTER	CAL Pt1	
13	Place the conductivity probe into the first standard and press  .	PLACE PROBE IN STANDARD NUM 1 PRESS ENTER	CAL Pt1	
14	Wait 0 to 5 minutes for the conductivity reading to stabilize. The system is continuously evaluating the data by applying a stability criteria until a stable condition is met.	AWAITING DATA STABILITY	Actual conductivity readings flashing	
15		PLACE PROBE IN STANDARD NUM 2 PRESS ENTER	CAL Pt2	Steps 15 through 17 are required when 2Pt or 3Pt is selected as the number of calibration points.
16	Remove the conductivity probe from the first standard, rinse it with distilled water and blot it dry with a lint-free tissue. Place the conductivity probe into the second standard and press  .	PLACE PROBE IN STANDARD NUM 2 PRESS ENTER	CAL Pt2	
17	Wait 0 to 5 minutes for the conductivity reading to stabilize. The system is continuously evaluating the data by applying a stability criteria until a stable condition is met.	AWAITING DATA STABILITY	Actual conductivity reading flashing	
18		PLACE PROBE IN STANDARD NUM 3 PRESS ENTER	CAL Pt3	Steps 18 through 20 are required when 3Pt is selected as the number of calibration points.
19	Remove the conductivity probe from the second standard, rinse it with distilled water and blot it dry with a lint-free tissue. Place the conductivity probe into the third standard and press  .	PLACE PROBE IN STANDARD NUM 3 PRESS ENTER	CAL Pt3	









Step	Operator Action	Scrolling Marquee	Main Display	Notes
20	Wait 0 to 5 minutes for the conductivity reading to stabilize. The system is continuously evaluating the data by applying a stability criteria until a stable condition is met.	AWAITING DATA STABILITY	Actual conductivity reading flashing	
21	No operator action needed. The system calculates a new cell constant and checks for errors.			If there is calibration related error, the appropriate error message will be displayed.
22	Press  to accept the new cell constant value. or Press  to abort the calibration without saving the new slope and E _o values. The values for the last saved calibration prior to the aborted calibration will be used in the measure mode.	AVG CELL CONSTANT PRESS ENTER TO ACCEPT OR PRESS EXIT TO ABORT	Calculated cell constant on second line	
23	No operator action needed. The system will enter the measure mode and remain on hold until the hold timer expires (default hold time is 5 minutes).	Actual temperature reading	Actual conductivity reading	















Step	Operator Action	Scrolling Marquee	Main Display	Notes
Conductivity Calibration Procedure using the Direct Calibration Feature				
1	Make sure that the analyzer is in the measure mode.	Actual temperature reading	Actual conductivity reading	
2	Press  to initiate the calibration.			CAL appears as mode
3	If the calibration password is active, enter the calibration password by pressing  /  to set the first digit,  to move to the next digit,  /  to set the values of the remaining digits and  to move through the remaining digits. Press  to accept the password.	ENTER PASSWORD	PASS ####	
4		CH1 or CH2 (flashing)	CAL CHnL	Displayed for two channel analyzer
5	Press  /  to select the channel that will be calibrated and press  to begin the calibration.	CH1 or CH2 (flashing)	CAL CHnL	Action required for two channel analyzer

Step	Operator Action	Scrolling Marquee	Main Display	Notes
6		SELECT ENTERING CELL CONSTANT OR USING STANDARDS	Std or CELL (flashing)	
7	Press  /  to scroll between Std or CELL, select Std and press  to accept the setting.	SELECT ENTERING CELL CONSTANT OR USING STANDARDS	Std (flashing)	
8		SCROLL THE NUMBER OF POINTS FOR CONDUCTIVITY CALIBRATION	2Pt, 3Pt or 1Pt (flashing)	
9	Press  /  to scroll through two point (2Pt), three point (3Pt) or one point (1Pt) conductivity calibration options and press  to accept the setting.	SCROLL THE NUMBER OF POINTS FOR CONDUCTIVITY CALIBRATION	2Pt, 3Pt or 1Pt (flashing)	
10		SCROLL YES FOR AUTO STANDARD RECOGNITION OR NO FOR MANUAL	AUtO YES or nO (flashing)	
11	Press  /  to scroll between YES or nO, select nO and press  to accept the setting.	SCROLL YES FOR AUTO STANDARD RECOGNITION OR NO FOR MANUAL	AUtO nO (flashing)	
12		PLACE PROBE IN STANDARD NUM 1 PRESS ENTER	CAL Pt1	
13	Place the conductivity probe into the first standard and press  .	PLACE PROBE IN STANDARD NUM 1 PRESS ENTER	CAL Pt1	
14	Wait 0 to 5 minutes for the conductivity reading to stabilize. The system is continuously evaluating the data by applying a stability criteria until a stable condition is met.	AWAITING DATA STABILITY	Actual conductivity readings flashing	
15		SCROLL STANDARD VALUE PRESS ENTER	### (first digit flashing)	
16	Enter the value of the standard at the measured temperature. Press  /  to set the first digit. Press  to move to the next digit. Press  /  to set the values of the remaining digits and press  to move through the remaining digits. Press  to move the decimal point and to change the measurement units.	SCROLL STANDARD VALUE PRESS ENTER	<u>###</u> (change digit flashing)	
17	Press  to accept the standard value and advance to the next screen.			

Step	Operator Action	Scrolling Marquee	Main Display	Notes
18		PLACE PROBE IN STANDARD NUM 2 PRESS ENTER	CAL Pt2	Steps 18 through 23 are required when 2Pt or 3Pt is selected as the number of calibration points.
19	Remove the conductivity probe from the first standard, rinse it with distilled water and blot it dry with a lint-free tissue. Place the conductivity probe into the second standard and press  .	PLACE PROBE IN STANDARD NUM 2 PRESS ENTER	CAL Pt2	
20	Wait 0 to 5 minutes for the conductivity reading to stabilize. The system is continuously evaluating the data by applying a stability criteria until a stable condition is met.	AWAITING DATA STABILITY	Actual conductivity reading flashing	
21		SCROLL STANDARD VALUE PRESS ENTER	#### (first digit flashing)	
22	Enter the value of the standard at the measured temperature. Press  /  to set the first digit. Press  to move to the next digit. Press  /  to set the values of the remaining digits and press  to move through the remaining digits. Press  to move the decimal point and to change the measurement units.	SCROLL STANDARD VALUE PRESS ENTER	#### (change digit flashing)	
23	Press  to accept the standard value and advance to the next screen.			
24		PLACE PROBE IN STANDARD NUM 3 PRESS ENTER	CAL Pt3	Steps 24 through 29 are required when 3Pt is selected as the number of calibration points.
25	Remove the conductivity probe from the second standard, rinse it with distilled water and blot it dry with a lint-free tissue. Place the conductivity probe into the third standard and press  .	PLACE PROBE IN STANDARD NUM 3 PRESS ENTER	CAL Pt3	
26	Wait 0 to 5 minutes for the conductivity reading to stabilize. The system is continuously evaluating the data by applying a stability criteria until a stable condition is met.	AWAITING DATA STABILITY	Actual conductivity reading flashing	
27		SCROLL STANDARD VALUE PRESS ENTER	#### (first digit flashing)	

Step	Operator Action	Scrolling Marquee	Main Display	Notes
28	<p>Enter the value of the standard at the measured temperature.</p> <p>Press  /  to set the first digit.</p> <p>Press  to move to the next digit.</p> <p>Press  /  to set the values of the remaining digits and press  to move through the remaining digits.</p> <p>Press  to move the decimal point and to change the measurement units.</p>	<p>SCROLL STANDARD VALUE</p> <p>PRESS ENTER</p>	<p>###</p> <p>(change digit flashing)</p>	
29	<p>Press  to accept the standard value and advance to the next screen.</p>			
30	<p>No operator action needed.</p> <p>The system calculates a new cell constant and checks for errors.</p>			<p>If there is calibration related error, the appropriate error message will be displayed.</p>
31	<p>Press  to accept the new cell constant value.</p> <p>or</p> <p>Press  to abort the calibration without saving the new slope and E_0 values. The values for the last saved calibration prior to the aborted calibration will be used in the measure mode.</p>	<p>AVG CELL CONSTANT</p> <p>PRESS ENTER TO ACCEPT OR</p> <p>PRESS EXIT TO ABORT</p>	<p>Calculated cell constant on second line</p>	
32	<p>No operator action needed.</p> <p>The system will enter the measure mode and remain on hold until the hold timer expires (default hold time is 5 minutes).</p>	<p>Actual temperature reading</p>	<p>Actual conductivity reading</p>	





Step	Operator Action	Scrolling Marquee	Main Display	Notes
Conductivity Calibration Procedure using the Manual Calibration Feature				
1	<p>Make sure that the analyzer is in the measure mode.</p>	<p>Actual temperature reading</p>	<p>Actual conductivity reading</p>	
2	<p>Press  to initiate the calibration.</p>			<p>CAL appears as mode</p>
3	<p>If the calibration password is active, enter the calibration password by pressing  /  to set the first digit,  to move to the next digit,  /  to set the values of the remaining digits and  to move through the remaining digits.</p> <p>Press  to accept the password.</p>	<p>ENTER PASSWORD</p>	<p>PASS</p> <p>###</p>	

Step	Operator Action	Scrolling Marquee	Main Display	Notes
4		CH1 or CH2 (flashing)	CAL CHnL	Displayed for two channel analyzer
5	Press  /  to select the channel that will be calibrated and press  to begin the calibration.	CH1 or CH2 (flashing)	CAL CHnL	Action required for two channel analyzer
6		SELECT ENTERING CELL CONSTANT OR USING STANDARDS	Stnd or CELL (flashing)	
7	Press  /  to scroll between Stnd or CELL, select CELL and press  to accept the setting.	SELECT ENTERING CELL CONSTANT OR USING STANDARDS	CELL (flashing)	
8		SCROLL THE CELL CONSTANT	#### #### (first digit flashing)	
9	Place the conductivity probe into the calibration standard.	SCROLL THE CELL CONSTANT	#### #### (first digit flashing)	
10	Enter the value of the cell constant so the displayed conductivity value matches the conductivity value of the standard at the measured temperature. Press  /  to set the first digit. Press  to move to the next digit. Press  /  to set the values of the remaining digits and press  to move through the remaining digits. Press  to move the decimal point.	SCROLL THE CELL CONSTANT	#### # #### (change digit flashing)	The displayed conductivity value is on the first line and the cell constant value is on the second line.
11	Press  to accept the standard value and advance to the next screen.			
12	Press  to accept the new cell constant value.	ACCEPT THE FINAL VALUE	Entered cell constant on second line	
13	No operator action needed. The system will enter the measure mode and remain on hold until the hold timer expires (default hold time is 5 minutes).	Actual temperature reading	Actual conductivity reading	

Calibration Abort Steps

The system allows the operator to abort the calibration or return to the calibration when  is pressed at any point during the calibration.



The following table lists the calibration abort steps with their marquee display and required operator actions.









Step	Operator Action	Scrolling Marquee	Main Display	Notes
Calibration Abort Exit Steps – If  is pressed at any point during the calibration, proceed with the following steps				
Exit 1		ARE YOU SURE? PRESS ENTER TO ABORT OR PRESS LAST SCREEN TO BACKUP	SUrE ?	
Exit 2	Press  to abort the calibration. or Press  to return to the last screen used in the calibration sequence prior to when  was pressed. Continue to follow the calibration steps according to the marquee and main display directions.	ARE YOU SURE? PRESS ENTER TO ABORT OR PRESS LAST SCREEN TO BACKUP	SUrE ?	
Exit 3		CALIBRATION ABORTED PRESS ENTER	CAL Abrt	
Exit 4	Press  to abort the calibration.	CALIBRATION ABORTED PRESS ENTER	CAL Abrt	
Exit 5	No operator action needed. The system will enter the measure mode and remain on hold until the hold timer expires (default hold time is 5 minutes).	Actual temperature reading	Actual sensor reading	

Calibration Error Codes

At any point during a calibration, the appropriate error message will be displayed if there is a calibration related error.

The following table lists common calibration error codes with their marquee display and required operator actions.

Error	Operator Action	Scrolling Marquee	Main Display	Notes
Stability Time Out Error				
Error 41	Press  to continue the calibration despite the reading instability. or Press  to abort the calibration and refer to Exit 3. Repeat the calibration or refer to the troubleshooting section.	READINGS WERE UNSTABLE PRESS ENTER TO CONTINUE CALIBRATION OR PRESS EXIT TO ABORT	E041	The required system stability was not reached and a time out error occurred. Perform electrode cleaning, conditioning and troubleshooting.

Error	Operator Action	Scrolling Marquee	Main Display	Notes
Calibration Errors				
Error 42	Press  to abort the calibration and refer to Exit 3. Verify that the correct buffers were used during the calibration, the buffer values were entered correctly and in the right order and the electrode is working properly and then repeat the calibration.	INVALID SLOPE PRESS ENTER	E042	The calculated slope was invalid. Buffer values were likely entered in the wrong sequence or wrong buffer values were entered.
Error 105	Press  to abort the calibration and refer to Exit 3.	AUTO BUFFER RECOGNITION FAILURE PRESS ENTER	E105	Repeat the calibration in the manual calibration mode.
Error 107	Press  to abort the calibration and refer to Exit 3.	CALIBRATION DATA TOO CLOSE TOGETHER PRESS ENTER	E107	Use new buffers or standards. Perform electrode cleaning, conditioning and troubleshooting.
Error 109	Press  to continue the calibration despite the bad slope. or Press  to abort the calibration and refer to Exit 3. Perform electrode cleaning and conditioning, refer to the troubleshooting section and repeat the calibration.	CH1 BAD SLOPE PRESS ENTER	E109	The calculated slope was outside of the recommended 80% to 110% range.
Error 110	Press  to continue the calibration despite the bad slope. or Press  to abort the calibration and refer to Exit 3. Perform electrode cleaning and conditioning, refer to the troubleshooting section and repeat the calibration.	CH2 BAD SLOPE PRESS ENTER	E110	The calculated slope was outside of the recommended 80% to 110% range.
Error 125	Press  to abort the calibration and refer to Exit 3. Verify that the correct buffers were used during the calibration, the buffer values were entered correctly and in the right order and the electrode is working properly and then repeat the calibration.	CH1 BAD OFFSET PRESS ENTER	E125	Use new buffers or standards. Perform electrode cleaning, conditioning and troubleshooting.
Error 126	Press  to abort the calibration and refer to Exit 3. Verify that the correct buffers were used during the calibration, the buffer values were entered correctly and in the right order and the electrode is working properly and then repeat the calibration.	CH2 BAD OFFSET PRESS ENTER	E126	Use new buffers or standards. Perform electrode cleaning, conditioning and troubleshooting.

5

SECTION 5 **Analyzer Maintenance**

Maintenance Schedule

The Thermo Scientific Orion 2100 series pH/ORP and conductivity analyzers are designed for simple maintenance. Follow the instructions in this section to ensure proper operation of your analyzer.

Recommendations

To ensure proper maintenance and good analyzer performance, a service logbook should be kept.

- Record the maintenance date and type of service work completed.
- Record the date that solutions are opened and when solutions expire.
- Tag each electrode cable with installation date of the electrode.

Weekly Maintenance

1. Check that the sample flow rate is 50 to 100 mL/min.
2. Check that there are no error indications and that the current measurement value is reasonable.
3. Check if the reference fill solution is adequate (if appropriate for the electrodes/probes in use).
4. Wipe the analyzer with a damp cloth to remove dirt and dust particles.

Monthly Maintenance

The calibration frequency depends on the operator's requirements for the most accurate and precise measurements.

Calibration

- Calibration intervals can be programmed using the setup mode. This will prompt the operator to recalibrate the analyzer after a specific amount of time has passed. Refer to Section 3, Use of the Setup Mode.

Replacement of Electrode Filling Solution

(If Appropriate for the Electrodes In Use)

Refer to Section 2, Installation of a New pH Electrode.

Electrode filling solution is meant to be a several month supply. Therefore, if reservoir is less than one quarter full, replace solution. This should be checked each month to ensure the electrode does not run dry.

1. Prepare the electrode according to the instruction sheet or manual that is packaged with the electrode.

Yearly Preventive Maintenance

Note: Dispose of all old solutions according to SDS instructions. Download SDS files for Thermo Scientific Orion products at www.thermofisher.com/water.

pH Electrode

1. Replace the pH electrode. Refer to Section 2, Installation of a New pH Electrode for detailed instructions.
2. Replace the sensing electrode (if appropriate for the electrodes/probes in use).

ORP Electrode

1. Replace the ORP electrode. Refer to Section 2, Installation of a New ORP Electrode for detailed instructions.

Conductivity Probe

1. Replace the conductivity probe every two years. Refer to Section 2, Installation of a New Conductivity Probe for detailed instructions.





Calibration Solutions



1. Replace all calibration buffers or standards and all other solutions.

6



SECTION 6 **Troubleshooting**





Diagnostics Mode





- From the measure mode, press  to enter the diagnostics mode. The  key allows access to menus used for system diagnostics.
- Each menu is sequential. Press  to scroll through the diagnostics menu selections.
-  can be pressed at any time to return to the measurement mode.

Default	Operator Action	Scrolling Marquee	Main Display	Notes
Diagnostics				
	<p>Press  while in the measure mode to enter the diagnostics mode.</p> <p>The system will enter the diagnostics mode at the calibration log menu.</p> <p>Press  to step through the menu items.</p>	CH1 CALIBRATION SLOPE AND E_0 CH2 CALIBRATION CELL CONSTANT CH1 ERROR LIST PRESS VIEW CH2 ERROR LIST PRESS VIEW CH1 – SELECT TIME/DATE TO VIEW MEASUREMENT LOG CH2 – SELECT TIME/DATE TO VIEW MEASUREMENT LOG SELECT TIME/ DATE TO VIEW STATUS LOG SOFTWARE REV NUMBER CH1 SERIAL NUMBER CH2 SERIAL NUMBER CH1 MODEL NUMBER CH2 MODEL NUMBER CH1 MEASURE mV AND NOISE CH2 MEASURE mV AND NOISE CH1 mA1 and mA2 OUTPUT VALUES SENSOR/TEMP CH2 mA1 and mA2 OUTPUT VALUES PRESS ENTER FOR THE DISPLAY TEST PRESS ENTER TO CONTINUE PRESS ENTER TO CONTINUE KEYPAD TEST PRESS ALL KEYS ONE AT A TIME	The display will change with each menu	If only one board is installed in the analyzer, only one menu option will be shown in the scrolling marquee instead of CH1 and CH2 menu options.



Calibration Log





- Displays up to the last twelve calibrations using three screens:
 1. Slope and E_0 (analyzers with a pH module or ISE module installed), mV offset (analyzers with an ORP module installed) or cell constant (analyzers with a conductivity module installed)
 2. Date and Time
 3. Temperature
- Press  to scroll between the three information screens for each calibration
- Press  /  to view the last twelve calibrations

Default	Operator Action	Scrolling Marquee	Main Display	Notes
Calibration Log				
	<p>Press  while in the measure mode to enter the diagnostics mode</p>			
	or	CALIBRATION SLOPE AND E_0	## . # (Slope) ## . # (E_0)	
	or	CALIBRATION OFFSET	### . # (mV offset)	
		CALIBRATION CELL CONSTANT	# . ### (Cell Constant)	
	<p>Press  to display the calibration time and date</p>	CALIBRATION TIME/DATE	HH:MM MM/DD or DD/MM	<p>Press  /  to scroll through the last 12 calibrations</p>



Default	Operator Action	Scrolling Marquee	Main Display	Notes
	Press  to display the calibration temperature and electrode response	CALIBRATION TEMP	##.##c (Temperature)	Press  /  to scroll through the last 12 calibrations
	Press  to proceed to the next menu			





Error List

- Displays a list of system events, warnings, and error codes that cause the yellow or red LED to light.
- The top line of the main display shows the error code and the bottom line shows the number of error codes (1-5 indicates that one of five error codes is being displayed).
- Press  /  to scroll through the error list.
- Press  to display a description of each error code on the marquee.



Default	Operator Action	Scrolling Marquee	Main Display	Notes
Error List				
		ERROR LIST PRESS VIEW	E### # - #	
	Press  to display the description of the error code on the marquee	Actual description of error code	E### # - #	
	Press  /  to scroll through the error list	Actual description of error code	E### # - #	
	Press  to proceed to the next menu			

Measurement Log

- Displays logged measurements according to log interval entered in setup mode.
- Press  to toggle between the measurement value and the data and time.
- Press  /  to scroll through the log entries.





Default	Operator Action	Scrolling Marquee	Main Display	Notes
Measurement Log				
		SELECT TIME/DATE TO VIEW MEASUREMENT LOG	HH:MM MM/DD or DD/MM	
	Press  /  to scroll through the log entries	SELECT TIME/DATE TO VIEW MEASUREMENT LOG	HH:MM MM/DD or DD/MM	
	Press  to scroll between the measurement log and the data and time display	Actual temperature value for logged measurement	Concentration and mV values for logged measurement	
	Press  to proceed to the next menu			

Status Log

- Displays a list of system events.
- Press  /  to scroll through the log entries.
- Press  to toggle between the log code and the data and time.

Software Revision

- Displays the software revision numbers of the two processors.

Default	Operator Action	Scrolling Marquee	Main Display	Notes
Status Log				
		SELECT TIME/DATE TO VIEW STATUS LOG	HH:MM MM/DD or DD/MM	
	Press  /  to scroll through the log entries	SELECT TIME/DATE TO VIEW STATUS LOG	HH:MM MM/DD or DD/MM	
	Press  to toggle between the log code and the data and time	PRESS UP/DOWN KEY TO VIEW STATUS LOG	Event code	
	Press  to proceed to the next menu			
Software Revision				
		SOFTWARE REV NUMBER	r # . # # r # . # #	
	Press  to proceed to the next menu			

Electronics Serial Number

- Displays the serial number of the electronics assembly.

Model Number

- Displays the model number of the system.



mV and Noise Measurements

- Displays the current mV measurement value and the noise associated with the measurement.





mA Output Values





- Displays current mA values for mA1 and mA2 outputs.

Default	Operator Action	Scrolling Marquee	Main Display	Notes
Electronic Serial Number				
		SERIAL NUMBER	### ###	
	Press  to proceed to the next menu			

Default	Operator Action	Scrolling Marquee	Main Display	Notes
Model Number				
		MODEL NUMBER	#### ####	
	Press  to proceed to the next menu			
mV and Noise Measurements				
		MEASURE mV AND NOISE	Current mV measurement and noise	
	Press  to proceed to the next menu			
mA Output Values				
		mA OUTPUT VALUES mA1 / mA2	Current mA output values for mA1 and mA2	
	Press  to proceed to the next menu			

Display Test

- Press  to start display test.
 - All the display segments will light up and the system will cycle through the LED colors.
 - Verify that all the display segments are on and that the LED colors are functional and press .
 - All the display segments will turn off except for the marquee display, which should show **PRESS ENTER TO CONTINUE**.
 - Verify that all the display segments are off and press .
 - The system will show a counting number pattern on both lines of the main display.
 - Verify that the display segments are functional and press  to proceed to the keypad test.

Default	Operator Action	Scrolling Marquee	Main Display	Notes
Display Test				
		PRESS ENTER FOR THE DISPLAY TEST	dISP tEst	
	Press  to start the test			
	Verify that all of the display segments are on and that the LED colors are functional	All segments on	All segments on	System will cycle through the LED colors
	Press  to proceed to the next part of the test			
	Verify that all of the display segments are off	PRESS ENTER TO CONTINUE	All segments off	
	Press  to proceed to the next part of the test			
	Verify that all of the numeric display segments are functional	PRESS ENTER TO CONTINUE	Count pattern Count pattern	
	Press  to proceed to the next menu			

Keypad Test

- The main display will show **0** and the Marquee will display **KEYPAD TEST PRESS ALL KEYS ONE AT A TIME**.
- Press all eight keys one at a time in any order.
- After the first key is pressed Error E033 will be displayed if a new key is not pressed within 10 seconds.

Default	Operator Action	Scrolling Marquee	Main Display	Notes
Keypad Test				
		KEYPAD TEST PRESS ALL KEYS ONE AT A TIME	0	
	Press all keys one at a time in any order	KEYPAD TEST PRESS ALL KEYS ONE AT A TIME	Display will show numbers 1 through 8 as keys are pressed	After the first key is pressed error E033 will be displayed if a new key is not pressed within 10 seconds
	No operator action needed The system will enter the measure mode if the keypad test is passed			

Slope Problems

Low Slope

Slope less than 80%

- Check electrode function, clean electrode, recalibrate, and if analyzer continues to read low, replace the electrode.
- Check electronics to read mV input correctly. Use electronic test kit (Cat. No. 180029) procedure for checking electronics function.

Input Signal	Expected Reading: $\pm (0.5 \text{ mV} + 0.1\%)$
0 mV	- 0.5 mV to + 0.5 mV
- 1000 mV	-1001.5 mV to - 998.5 mV
+ 1000 mV	+ 998.5 mV to + 1001.5 mV

- Buffers contaminated or incorrectly made – verify calibration with fresh buffers.
- Buffers interchanged – check values on buffers and repeat calibration. If using custom buffers, verify values for each buffer.
- Buffers added in wrong sequence – check sequence of buffers and repeat calibration.

High Slope

Slope greater than 110%

- Calibration buffers contaminated – verify calibration with fresh buffers.
- Electronics failure – reset the analyzer. Refer to Section 6, Resetting the Analyzer.
- Cables interchanged – verify wiring of cable connections to terminal strip. Refer to Section 2, Wiring the Analyzer.
- Check the connection of the cable markers for the corresponding electrode. Cable markers are the white tape at the cap connector on the cable.
- Electrode coated – clean or replace the electrode.

Cell Constant Problems

- Check conductivity probe function, clean probe, recalibrate, and if analyzer continues to read low, replace the probe.

Automatic Standard Recognition Failure

- If using the automatic calibration feature, 100 $\mu\text{S}/\text{cm}$, 1413 $\mu\text{S}/\text{cm}$ and/or 12.9 mS/cm conductivity standards must be used and the nominal cell constant of the conductivity probe must be entered in the setup mode. For the analyzer to recognize the conductivity standard, enter the nominal cell constant of the conductivity probe that is attached to the analyzer (usually 0.1 cm^{-1} , 0.475 cm^{-1} or 1.0 cm^{-1}).

Note: For the analyzer to recognize the conductivity standard, the entered cell constant must be accurate within a factor of 3. For example, if the entered nominal cell constant is 1.0 cm^{-1} , the actual cell constant of the conductivity probe must be in the range of 0.3 cm^{-1} to 3.0 cm^{-1} to allow the analyzer to identify the conductivity standard and perform the automatic calibration.

- If using conductivity standards with values other than 100 $\mu\text{S}/\text{cm}$, 1413 $\mu\text{S}/\text{cm}$ and/or 12.9 mS/cm , use the manual calibration feature.
- Check electronics to read mV input correctly. Use electronic test kit (Cat. No. 180029) procedure for checking electronics function.

Input Signal	Expected Reading: $\pm (0.5\text{ mV} + 0.1\%)$
0 mV	- 0.5 mV to + 0.5 mV
- 1000 mV	-1001.5 mV to - 998.5 mV
+ 1000 mV	+ 998.5 mV to + 1001.5 mV

- Conductivity standards contaminated or incorrectly made – verify calibration with fresh standards.
- Conductivity standards interchanged – check values on standards and repeat calibration.
- Conductivity standards added in wrong sequence – check sequence of standards and repeat calibration.

Troubleshooting Matrix

Malfunction	Possible Cause	Remedy
Noisy	Blocked reference junction on pH electrode	Make sure electrolyte is flowing properly.
	pH electrode or conductivity probe failure	Check the cable connection and location of wiring to terminal strip. Refer to Section 2.
	Temperature probe failure	Disconnect ATC. Temperature should read 25 °C (E101). Replace if necessary.
	Faulty electrode cables	Replace electrode cables.
Excessive Drift	Sample concentration varying	Check sample status
	Blocked reference junction on pH electrode	Make sure electrolyte is flowing properly.
	pH electrode or conductivity probe failure	Check the cable connection and location of wiring to terminal strip. Refer to Section 2.
	Temperature probe failure	Disconnect ATC. Temperature should read 25 °C (E101). Replace if necessary.
Does Not Calibrate Properly	Contaminated buffers or standards	Use new buffers or standard solutions.
	Buffers or standards interchanged	Repeat calibration using buffers or standards in the correct sequence.
	Temperature probe failure	Disconnect ATC. Temperature should read 25 °C (E101). Replace if necessary.
	Electronics failure or bad setup	Reset the analyzer. Refer to Section 6.
High Readings	Analyzer out of calibration	Recalibrate the analyzer. Refer to Section 4.
Over-Range Readings	Electrode connections loose or bad	Verify the electrode connections to the electrode cables.
	Electrode wiring	Electrodes not properly wired to terminal strip. Refer to Section 2.
	Blocked reference junction on pH electrode	Make sure electrolyte is flowing properly.
	Electrode or probe failure	Electrode or probe is shorted, cracked or damaged. Install a new electrode or probe. Refer to Section 2.
	Electronics failure or bad setup	Reset the analyzer. Refer to Section 6.
	Analyzer out of calibration	Recalibrate the analyzer. Refer to Section 4.
Low Readings	Analyzer out of calibration	Recalibrate the analyzer. Refer to Section 4.
	Electronics failure	Try resetting the analyzer. Refer to Section 6 or consult Technical Support.
Default	Battery failure	Consult Technical Support.
	Electronics failure	Reset the analyzer. Refer to Section 6.

Error/Event Codes

Error/event codes will be in the format “E###”. Some of these are errors, some are warnings, and some are purely informational. The first digits identify the type of error or event as identified in the table below.

Displayed Event Code	Description	Cause	Troubleshooting
System Status Codes			
A711	ALARM1 CH1 ON	Alarm 1 channel 1 engaged (closed)	
A712	ALARM2 CH1 ON	Alarm 2 channel 1 engaged (closed)	
A713	ALARM3 CH1 ON	Alarm 3 channel 1 engaged (open)	
A714	AIR PUMP ON	Air pump engaged	
A721	ALARM1 CH2 ON	Alarm 1 channel 2 engaged (closed)	
A722	ALARM2 CH2 ON	Alarm 2 channel 2 engaged (closed)	
A723	ALARM3 CH2 ON	Alarm 3 channel 2 engaged (open)	
A811	ALARM1 CH1 OFF	Alarm 1 channel 1 disengaged (open)	
A812	ALARM2 CH1 OFF	Alarm 2 channel 1 disengaged (open)	
A813	ALARM3 CH1 OFF	Alarm 3 channel 1 disengaged (closed)	
A814	AIR PUMP OFF	Air pump disengaged	
A821	ALARM1 CH2 OFF	Alarm 1 channel 2 disengaged (open)	
A822	ALARM2 CH2 OFF	Alarm 2 channel 2 disengaged (open)	
A823	ALARM3 CH2 OFF	Alarm 3 channel 2 disengaged (closed)	
C500	CAL MODE	Calibration mode entered	
R400	MEAS MODE	Measurement mode entered	
S600	SETUP MODE	Setup mode entered	
E028	POWER FAIL	Brown out or power failure and system has stopped processing	Verify custom settings
E033	KEYPAD FAILURE	User did not press the keys during a diagnostic mode keypad test or keypad broken	Repeat diagnostic mode keypad test
E034	CAL PASS INCORRECT	User entered incorrect calibration password	Verify password
E035	SYSTEM PASS INCORRECT	User entered incorrect system password	Verify password
E036	USER VALUE INCORRECT	User entered a value that is out of range	Verify value and re-enter
E037	POWER RETURN	System started processing after brown out or power failure	Verify custom settings
E041	CALIBRATION TIMEOUT	The electrode has not reach stability within the specified time	The system code may be due to out of range measurements or an invalid previous calibration
E040	BLANK INCORRECT	Blank greater than 1ppb	Verify blank scrolled blank value is correct and less than 1ppb. Repeat DKA if needed.
E042	INVALID SLOPE	Invalid slope obtained during calibration	Check electrodes, electrode cables and connectors for defects or shorts. Replace electrodes, if necessary. Recalibrate using new standards in the correct calibration sequence.









Displayed Event Code	Description	Cause	Troubleshooting
System Event/Error Codes - Yellow LED			
E004	DEFAULT VALUES	Analyzer has been reset or is new out of box	Calibrate the analyzer
E021	HARDWARE FAULT	System error	Contact Technical Support 1-800-225-1480
E101	CH1 TEMP OUT OF RANGE	Temperature sensor on channel 1 out of range (5 °C to 45 °C) for ISE	Check ATC cable and probe connections. Replace if needed.
E102	CH2 TEMP OUT OF RANGE	Temperature sensor on channel 2 out of range (5 °C to 45 °C) for ISE	Check ATC cable and probe connections. Replace if needed.
E111	CH1 CAL DUE	User calibration required on channel 1. No calibration has been performed in user specified time interval.	Recalibrate the analyzer.
E112	CH2 CAL DUE	User calibration required on channel 2. No calibration has been performed in user specified time interval.	Recalibrate the analyzer
E127	CH1 mA1 OVER RANGE	Measured sensor value above mA1 high limit value on channel 1	Verify user selectable mA1 high limit value in setup mode
E128	CH1 mA1 UNDER RANGE	Measured sensor value below mA1 low limit value on channel 1	Verify user selectable mA1 low limit value in setup mode
E129	CH1 mA2 OVER RANGE	Measured temperature value above mA2 high limit value on channel 1	Verify user selectable mA2 high limit value in setup mode
E130	CH1 mA2 UNDER RANGE	Measured temperature value below mA2 low limit value on channel 1	Verify user selectable mA2 low limit value in setup mode
E131	CH2 mA1 OVER RANGE	Measured sensor value above mA1 high limit value on channel 2	Verify user selectable mA1 high limit value in setup mode
E132	CH2 mA1 UNDER RANGE	Measured sensor value below mA1 low limit value on channel 2	Verify user selectable mA1 low limit value in setup mode
E133	CH2 mA2 OVER RANGE	Measured temperature value above mA2 high limit value on channel 2	Verify user selectable mA2 high limit value in setup mode
E134	CH2 mA2 UNDER RANGE	Measured temperature value below mA2 low limit value on channel 2	Verify user selectable mA2 low limit value in setup mode

Displayed Event Code	Description	Cause	Troubleshooting
System Error Codes - Red LED			
E001	HARDWARE FAULT	System error	Contact Technical Support 1-800-225-1480
E002	HARDWARE FAULT	System error	Contact Technical Support 1-800-225-1480
E018	HARDWARE FAULT	System error	Contact Technical Support 1-800-225-1480
E019	HARDWARE FAULT	System error	Contact Technical Support 1-800-225-1480
E020	HARDWARE FAULT	System error	Contact Technical Support 1-800-225-1480
E024	HARDWARE FAULT	System error	Contact Technical Support 1-800-225-1480
E026	HARDWARE FAULT	System error	Contact Technical Support 1-800-225-1480
E027	HARDWARE FAULT	System error	Contact Technical Support 1-800-225-1480
E029	HARDWARE FAULT	System error	Contact Technical Support 1-800-225-1480
E030	HARDWARE FAULT	System error	Contact Technical Support 1-800-225-1480
E038	HARDWARE FAULT	System error	Contact Technical Support 1-800-225-1480
E103	CH1 MEAS OVER RANGE	Measurement is over range on channel 1, the display should also be flashing '9999'	Check if electrode is not connected, electrode cables are faulty or electrode junction is fouled
E104	CH2 MEAS OVER RANGE	Measurement is over range on channel 2, the display should also be flashing '9999'	Check if electrode is not connected, electrode cables are faulty or electrode junction is fouled
E109	CH1 BAD SLOPE	Last calibration produced a bad slope on channel 1. Slope is less than 45 mV/decade or more than 62 mV/decade or the calibration standards may have been interchanged.	Recalibrate the analyzer using fresh standards. Recalibrate using the correct sequence of standards.
E110	CH2 BAD SLOPE	Last calibration produced a bad slope on channel 2. Slope is less than 45 mV/decade or more than 62 mV/decade or the calibration standards may have been interchanged.	Recalibrate the analyzer using fresh standards. Recalibrate using the correct sequence of standards.
E113	CH1 CAL OVERDUE	Calibration is overdue on channel 1 by more than 50% of the user specified time interval	Recalibrate the analyzer
E113	CH2 CAL OVERDUE	Calibration is overdue on channel 2 by more than 50% of the user specified time interval	Recalibrate the analyzer
E121	CH1 TEMP BROKEN	Temperature sensor on channel 1 broken or out of range	Check ATC cable connections and probe for damage. Replace if needed.
E122	CH2 TEMP BROKEN	Temperature sensor on channel 2 broken or out of range	Check ATC cable connections and probe for damage. Replace if needed.
E125	CH1 BAD OFFSET	Last calibration produced a bad E_0 offset on channel 1	Recalibrate the analyzer using fresh standards. Check electrode connections. Replace electrode, if needed.
E126	CH2 BAD OFFSET	Last calibration produced a bad E_0 offset on channel 2	Recalibrate the analyzer using fresh standards. Check electrode connections. Replace electrode, if needed.

Resetting the Analyzer

The Thermo Scientific Orion 2100 series pH/ORP and conductivity analyzers allow the user to reset the analyzer through the setup mode or by a hard reset. Resetting the analyzer will restore all settings in the setup mode to factory default values.

WARNING: Resetting the analyzer will erase all data logs including calibration, and password protection settings for setup and calibration. The analyzer will reset setup parameters to factory default settings.

Operator Action	Scrolling Marquee	Main Display	Notes
Press  in the measure mode to enter the setup mode			
	Last menu used in setup mode	SEL SCm	SETUP appears as mode
Press  /  until RSET appears in the marquee			
	RSET (flashing)	SEL SCm	
Press  to reset the analyzer			
	PRESS TEST VIEW ENTER TO RESET	rSEt ?	
Press  Press  Press  When the reset is complete, the system will return to the measure mode. The operator will need to re-enter the setup mode to continue programming the setup parameters. Press  to return to the setup mode.	PRESS TEST VIEW ENTER TO RESET	rSEt ?	This command resets all previously set parameters to factory default values. Use this command only to set the analyzer to original factory setup values.

Hard Reset

A hard reset should be performed if the analyzer becomes unresponsive or the status indicators are flashing. Perform the following sequence:

- Carefully open the front cover of the electronics case (loosen the 4 corner screws).
- Press the small button located on the raised portion of the PCB to reset the electronics.
- Close the front cover of the electronics case and tighten the screws.

System settings and calibrations are preserved and analyzer returns to the measure mode. The actual value for concentration and temperature will be displayed if the electrodes are properly installed. If the system does not reset, contact Technical Support at 1-800-225-1480 for assistance.

Serial Number and Software Revision

In the event you require technical assistance, please have the serial number available when calling for assistance along with the software version.

- The analyzer serial number is located on the underside of the electronics enclosure or if panel mounted then on the backside of the electronics enclosure.
- The software revision is accessed through the diagnostics mode.

Service and Repair

Extended Warranty

The Thermo Scientific Orion 2100 series pH/ORP and conductivity analyzers provide measurements through a combination of our premium electrode technology and user friendly scrolling marquee to set a new industry standard for reliability. Similarly, Thermo Fisher Scientific now offers multiple levels of service programs to meet your needs beyond the One-Year Product Warranty period.

A cost effective way to blend your in-house expertise with our service and support experts, to get the support you need at a specified annual contracted price. This warranty plan must be purchased within ninety days of the initial product purchase date.

- Extends the features of the standard One-Year Product Warranty for a second or third year.
- Provides access to the manufacturer's technical experts at Thermo Scientific Orion Support Call Center, 1-800-225-1480, Monday through Friday, 8:00 AM – 5:00 PM EST.
- After telephone consultation, we will send you required parts for installation by your on-site technician.

Service Kit to Expand Standard Warranty

With in-house resources at a premium, many organizations require immediate access to manufacturer expertise. Purchase a service kit within ninety days of the initial product purchase date to eliminate the costly effects of down time.

- Provides a contracted, cost-effective means to enhance level of support offered during the product warranty period.
- Provides priority access to the manufacturer's technical experts at Thermo Scientific Orion Support Call Center.
- Provides a service kit to expedite on-site repairs in conjunction with telephone consultation with Thermo Scientific Orion product experts.

The service kit includes:

- Power supply
- Front panel display
- Electrode cables

Advanced Replacement

When down-time is a cost factor to be strictly controlled, the advanced replacement service plan is often times the best choice.

- Enhances level of support offered during the standard One-Year Product Warranty.
- Provides access to the manufacturer's technical experts at Thermo Scientific Orion Support Call Center and repair facilities.
- If, after reasonable remote diagnostics and trouble-shooting attempts, we determine the analyzer to be non-functioning, we will make all reasonable effort to get required parts or equipment out to your facility by the following day for installation by your on-site technician.
- Offers predictable expenditure through fixed annual contract price.

Not sure which plan is best for you?

Ask your Thermo Scientific Orion products sales representative to put you in touch with the service plan manager. We have additional service options that are sure to address your concerns.

Installation and Start-Up

To help you achieve optimum performance, rely on us to provide you with an efficient and quality installation and the start-up support you need to be up and running quickly. Our service representatives are highly trained, experienced, and certified for your product and will be there to make sure that your instrumentation delivers to specifications.

Remedial Service

This is a one-day service engineer on-site visit to your facility for remedial service events at standard response time. Consider this plan an excellent uplift to one of the aforementioned programs.

Preventive Maintenance Programs

All precision-made scientific equipment requires preventive maintenance and calibration checks to perform at their maximum effectiveness. Consider a fixed-fee preventive maintenance contract to have one of our experts perform the following tasks:

- Sampling check
- Full validation test
- Visual check for worn, loose or damaged parts
- Replacement of consumables (additional charge for consumables)
- Diagnostic check to verify all operating parameters are within the factory specifications
- Check analyzer electrodes, flows and pressures
- Clean and replace any wearable items

7

SECTION 7 **Customer Service**

Notice of Compliance

This equipment generates, uses and can radiate radio frequency energy and if not installed and used in accordance with the user guide, may cause interference to radio communications. It has been tested and found to comply with the limits for a Class A computing device pursuant to Subpart J of Part 15 of FCC Rules, which are designed to provide reasonable protection against such interference when operated in a commercial environment. Operation of this equipment in a residential area is likely to cause interference in which case the user, at his own expense, will be required to take whatever measure may be required to correct the interference.

“This digital apparatus does not exceed the (Class A) limits for radio noise emissions from digital apparatus set out in the Radio Interference Regulations of the Canadian Department of Communications.”

Statement of Conformity

ThermoFisher
SCIENTIFIC

STATEMENT OF CONFORMITY



^[1] **Manufacturer**

Thermo Fisher Scientific
22 Alpha Road
Chelmsford, MA 01824
USA

^[2] **Authorized Representative**

Thermo Electron LED GmbH
Robert-Bosch-Str. 1
63505 Langenselbold
Germany

^[3] **Product Type**

Thermo Scientific Orion 2100 Series Analyzers

^[4] **Model Name(s)**

2102PH – pH/ORP Monitor	2117HL – High Level Chloride monitor
2104CD – Conductivity Monitor	2117LL – Low Level Chloride Monitor
2109XP – Fluoride Monitor	2117XP – Chloride Monitor
2110XP – Ammonia Monitor	2118XP – Oxygen Scavenger Monitor
2111LL – Low Level Sodium Monitor	2120XP – Calcium Hardness Monitor
2111XP – Sodium Monitor	

^[5] **Rated Voltage, Rated Frequency**

100-120V and 200-240V, 50/60 Hz

^[6] We herewith declare under our sole responsibility that the above mentioned products meet the provisions of the following EC Directives and harmonized standards:

^[7] **EC Directives**

2014/30/EU Electromagnetic Compatibility Directive
2014/35/EU Low Voltage Directive
2011/65/EU RoHS Directive

^[8] **Standards**

EN 61326-1:2013
EN 61010-1:2010
EN 50581:2012

^[9] This declaration is valid for the product(s) manufactured after the date listed below.

Chelmsford, MA
15, December 2016

Shervin Ghorab
Compliance Manager
Thermo Fisher Scientific

271818-000 Rev. A

WEEE Compliance



This product is required to comply with the European Union's Waste Electrical & Electronic Equipment (WEEE) Directive 2012/19/EU effective February, 2014. It is marked with the following symbol:

Thermo Fisher Scientific has contracted with one or more recycling/disposal companies in each EU Member State and this product should be disposed of or recycled through them. Further information on compliance with these directives, the recyclers in your country, and information on Thermo Scientific Orion products that may assist the detection of substances subject to the RoHS Directive are available at www.thermo.com/WEEERoHS.

Terms and Conditions

For products not listed in this warranty statement, please visit our website at www.thermofisher.com/water.

Contact Information

For updated contact information, visit www.thermofisher.com/water.

Thermo Fisher Scientific Inc.
22 Alpha Road,
Chelmsford, MA 01824, USA
Toll Free: 800-225-1480
Tel: 978-232-6000
Dom. Fax: 978-232-6015
Int'l Fax: 978-232-6031

Minimum Order

The minimum order requirement is \$100 for Thermo Scientific Orion process products. An order is considered to be a purchase order for products to be shipped to a single location. International minimum order requirements may vary. Contact your international coordinator for details.

Rush Orders

For customers in the U.S., rush orders received before 12 pm Eastern Time will be shipped the same day. Rush orders received after 12 noon Eastern Time will be shipped the next business day.

For customers and dealers in Canada, rush orders will be shipped within 2 business days. For customers and dealers outside the U.S. and Canada, contact your international coordinator for rush order scheduling. All rush orders carry a \$50 incremental charge per order. FOB: Beverly. Freight charges are prepaid and added or freight collect. All rush order processing is subject to stock availability.

Returning Goods

Permission to return Thermo Scientific Orion products must be obtained prior to return. Contact us within 30 days of receipt of goods for a return authorization number.

Hazardous Materials

Some materials are designated corrosive/oxidizer by DOT and IATA. Some materials may require special labeling and handling. Carriers may add additional freight charges for handling/transporting these materials. Consolidating such material with other products may be prohibited. Additional freight charges are billed to you per FOB terms. Advise manufacturer of shipping instructions for these hazardous materials to reduce your freight costs.

Restocking Charge

Permission to return new, excess inventory must be obtained prior to return. If any item is authorized to be returned for credit as a result of an incorrect purchase without a reorder, a 25% restocking charge of the price paid for the product will be made. International customer's restocking fee of 25% will be off the international price.

Only new (in the box) goods may be returned within 30 days of shipment from manufacturer. Older items, 9 digit parts and discontinued items cannot be returned for credit.

Short Shipments

Manufacturer must be notified within 30 days of receipt of invoice of any item or billing discrepancies. All substantiated claims will be remedied by a credit memo and a new order placed for short shipment. Any shipment discrepancy claimed after 30 days of invoice date will not be honored and credit will not be issued by manufacturer.

Force Majeure

Manufacturer shall not be liable for failure to perform or for delay in performance due to fire, flood, strike, or other labor difficulty, act of God, act of any governmental authority or of the purchaser, riot, embargo, fuel or energy shortage, wrecks or delays in transportation, inability to obtain necessary labor, materials, or manufacturing facilities from usual sources, or due to any cause beyond its reasonable control. In the event of a delay in performance due to any such cause, the date of delivery or time for completion of performance will be extended by a period of time reasonably necessary to overcome the effect of such delay.

Warranty

Thermo Scientific Orion process products are warranted to be free from defects in material and workmanship for a period of 12 months from date of installation or 18 months from date of shipment, whichever is earlier, when used under normal operating conditions and in accordance with the operating limitations and maintenance procedures given in the user guide and when not having been subjected to accident, alteration, misuse or abuse. This warranty is also conditioned upon expendable and consumable items (diffusion tubing, electrodes and all solutions) being stored at temperatures between 5 °C and 45 °C (40 °F and 110 °F) in a non-corrosive atmosphere and within the shelf life printed on the product.

In the event of failure within the warranty period, the manufacturer or its authorized dealer will, at the option of manufacturer, repair or replace the product nonconforming to the above warranty or will refund the purchase price of the product.

The warranty described is exclusive and in lieu of all other warranties whether statutory, express, or implied including, but not limited to, any implied warranty of merchantability or fitness for a particular purpose and all warranties arising from the course of dealing or usage of trade. The buyer's sole and exclusive remedy is for repair or replacement of the non-conforming part thereof, or refund of the purchase price, but in no event shall the manufacturer (its contractors and suppliers of any tier) be liable to the buyer or any person for any special indirect, incidental, or consequential damages whether the claims are used in contract, in tort (including negligence), or otherwise with respect to or arising out of the product furnished hereunder.

Process products used at overseas nuclear facilities are also subject to the manufacturer's nuclear terms and conditions. Contact the manufacturer if you do not have a copy.

Representations and warranties made by any person, including its authorized dealers, distributors, representatives, and employees of the manufacturer, which are inconsistent or in addition to the terms of this warranty shall not be binding upon manufacturer unless in writing and signed by one of its officers.

Appendix

Default Values

pH/ORP

E_0 default: 0.0 mV

Slope default: 100 % (59.15 mV / decade)

Slope range: 80 % to 110 % (47.3 mV/decade to 65.1 mV / decade)

C_{ISO} : 7

Conductivity

Cell constant default: 0.1 cm^{-1}

Specifications

pH Measurement	
Range	0 to 14
Resolution	0.1, 0.01
Relative Accuracy	± 0.01
Hold Function	Yes
Auto-Buffer Recognition	Yes
Solution Compensation	Yes
mV/ORP Measurement	
Range	$\pm 1999 \text{ mV}$
Resolution	1 mV
Relative Accuracy	$\pm (0.5 \text{ mV} + 0.1 \%)$
E_H ORP Mode	Yes
Temperature Measurement	
Range	-10 to 110 °C
Resolution	0.1 °C
Relative accuracy	$\pm 0.5 \text{ °C}$
Temperature Display	Yes
Temperature Compensation	Automatic and manual
Continuous Temperature Readings	Yes
ATC Probe Connection Detection	Yes

Conductivity Measurement	
Range	0.001 $\mu\text{S}/\text{cm}$ to 1000 mS/cm , cell constant dependent
Resolution	3 significant digits
Relative Accuracy	0.5 % \pm 1 digit
Auto-Ranging	Yes
Range Locking	Yes
Cell Constant	0.001 to 199.9 cm^{-1}
Probe Type	Cell with temperature sensor
Reference Temperature	25 °C
Temperature Compensation	Linear (0.0 to 10.0 %/C), nLF, NaCl, HCl, NH_3
Solution Compensation	Yes
2-Electrode Probes	Yes
4-Electrode Probes	Yes
TDS Range	0 to 19999 mg/L
Salinity Range	0.1 to 80.0 ppt NaCl equivalent
Resistivity Range	0.001 Megohm to 18 Megohm
Resistivity Resolution	100 ohm-cm
Resistivity Relative Accuracy	0.5 % \pm 1 digit
pH Calibration	
pH Auto-Calibration	Yes
pH Manual Calibration	Yes
Number of pH Calibration Points	1 to 3
Buffer Sets	US, EURO
Calibration Type	Point to point
mV/ORP Calibration	
Relative mV Calibration	Yes
E_{H} ORP Calibration	Yes
Conductivity Calibration	
Cell Constant Adjustment Method	Yes
Conductivity Direct Calibration	Yes
Conductivity Automatic Calibration	Yes
Display Features	
Type	Custom backlit LCD with scrolling marquee
Size	54 mm x 76 mm (2 1/8 in x 3 in)
Text Display	Scrolling marquee with instructions for setup, calibration and diagnostics menus
Inputs	
pH Electrode	Tinned leads
ATC Probe	30 Kohm, PT100, PT1000
Conductivity Probe	Tinned leads

Outputs	
Number of Analog Outputs	2 per channel
Analog Outputs	Galvanically isolated
Output Selections	0 to 20 mA or 4 to 20 mA
Programmable Range	Yes
Analog Output Assignments	Sensor and temperature, per channel
Conductivity Log and Linear Output Options	Yes
Alarm Outputs	
Number of Relay Outputs	3 per channel
Maximum Relay Load	250 VAC/5A, 30 VDC/5A
Minimum Value Alarm	Yes
Maximum Value Alarm	Yes
Error Alarm	Yes
Calibration Alarm	Yes
Programmable Minimum and Maximum Values	Yes
Power	
Power Input	100 to 120 V; 200 mA or 200 to 240 V; 100 mA 50 to 60 Hz AC
Analyzer Features	
Startup Reset	Yes
Hardware Calibration Function	Yes
Nonvolatile Memory	Yes
Battery Backup (Replaceable)	Yes
Regulatory And Safety	CE, CSA, FCC class A limits
Rolling Measurement Data Logging	Yes
Number of Data Log Points	1000 points
Data Log Function	Timed
Data Log Timed Intervals	1 minute to 99 hours and 59 minutes
Rolling Event Data Logging	Yes
Number of Event Log Points	100 points
Event Log Function	Error, calibration, power, alarm, offset
Calibration Log	Yes
Software Features	
Analyzer Serial Number	Yes
Self Test and Diagnostics	Yes
Real Time Clock	Yes
Password Protection	Yes
Programmable Alarms	High, low, error, calibration/offline
Reset Function	Yes

Environmental Operating Conditions	
Ambient Operating Temperature	5 to 45 °C
Relative Humidity	5 to 95 %, non-condensing
Storage Temperature	-20 to 60 °C
Storage Humidity	5 to 95 %, non-condensing
Altitude	Sea level to 2000 M
Case Material	Valox 364
Ingress Protection Rating	IP66 and NEMA 4X (2100 electronics module)
Shock and Vibration	
Vibration, Shipping and Handling	0 to 60 Hz @ 1 G load
Shock, Drop Test in Packaging	36° on all sides and corners

Ordering Information

Cat. No.	Description
2102PH	2102PH single channel pH/ORP analyzer only
2102PH1SC	2102PH single channel analyzer and ultra pure water (UPW) pH kit, includes flow cell, 2001SC ROSS® pH electrode, electrode cable (2001EC), ATC probe and buffers (pH 4, 7 and 10)
2102PH1X	2102PH single channel analyzer and ORP kit, includes ORP electrode (110250) and ORP standard (967901)
2102PH2	2102PH dual channel pH/ORP analyzer only
2102PH2SC	2102PH dual channel analyzer and ultra pure water (UPW) pH kit, includes (2) flow cells, (2) x 2001SC ROSS pH electrodes, (2) electrode cables (2001EC), (2) ATC probes and buffers (pH 4, 7 and 10)
2102PH2X	2102PH dual channel analyzer and ORP kit, includes (2) ORP electrodes (110250) and ORP standard (967901)
2104CD	2104CD single channel conductivity analyzer only
2104CD1SS	2104CD single channel analyzer and ultra pure water (UPW) conductivity kit, includes 2002SS conductivity cell, flow cell and 100 µS/cm conductivity standard (011008)
2104CD2	2104CD dual channel conductivity analyzer only
2104CD2SS	2104CD dual channel analyzer and ultra pure water (UPW) conductivity kit, includes (2) x 2002SS conductivity cells, (2) flow cells and 100 µS/cm conductivity standard (011008)
21PHCD2	2100 series dual channel pH/ORP and conductivity analyzer only
2100PH2	Second channel module for pH/ORP
2100CD2	Second channel module for conductivity
2001SC	ROSS combination pH electrode with screw cap
2001EC	1 meter electrode cable for use with 2001SC electrode
20015M	5 meter electrode cable for use with 2001SC electrode
110250	ORP electrode with cable and unterminated ends
2002SS	Stainless steel 2-electrode conductivity cell, 0.01 µS/cm to 300 µS/cm
2002CC	Carbon 4-electrode conductivity cell, 10 µS/cm to 200 mS/cm

Cat. No.	Description
2100DC	RS232C/485 digital communications
2001FC	Flow cell for 2001SC ROSS pH electrode
2100FCA1	Flow cell adapter for 2100R series ROSS Ultra [®] industrial pH electrodes
2100FCA2	Flow cell adapter for 2002SS conductivity cell
2100AMP	Pre-amp for 2100 series analyzers
2100SMK	Sample panel mounting kit
2100PMK	Pipe mounting kit
2100TM	Automatic temperature compensation (ATC) probe, Pt1000, 5 meter cable

Mounting Dimensions

Panel Mounting, Version 1

Note: All dimensions are in inches.

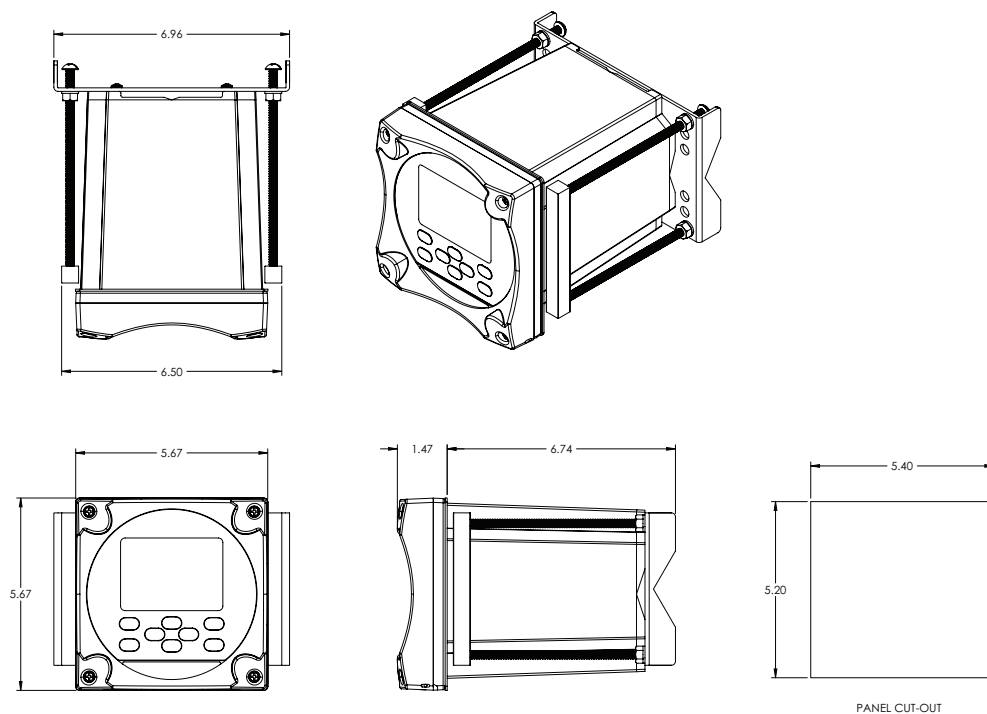

Panel Mounting, Version 2

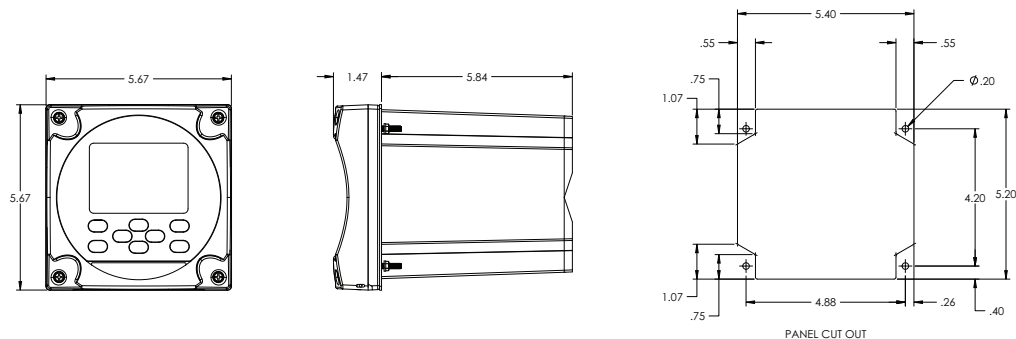

Pipe Mounting

Note: All dimensions are in inches.

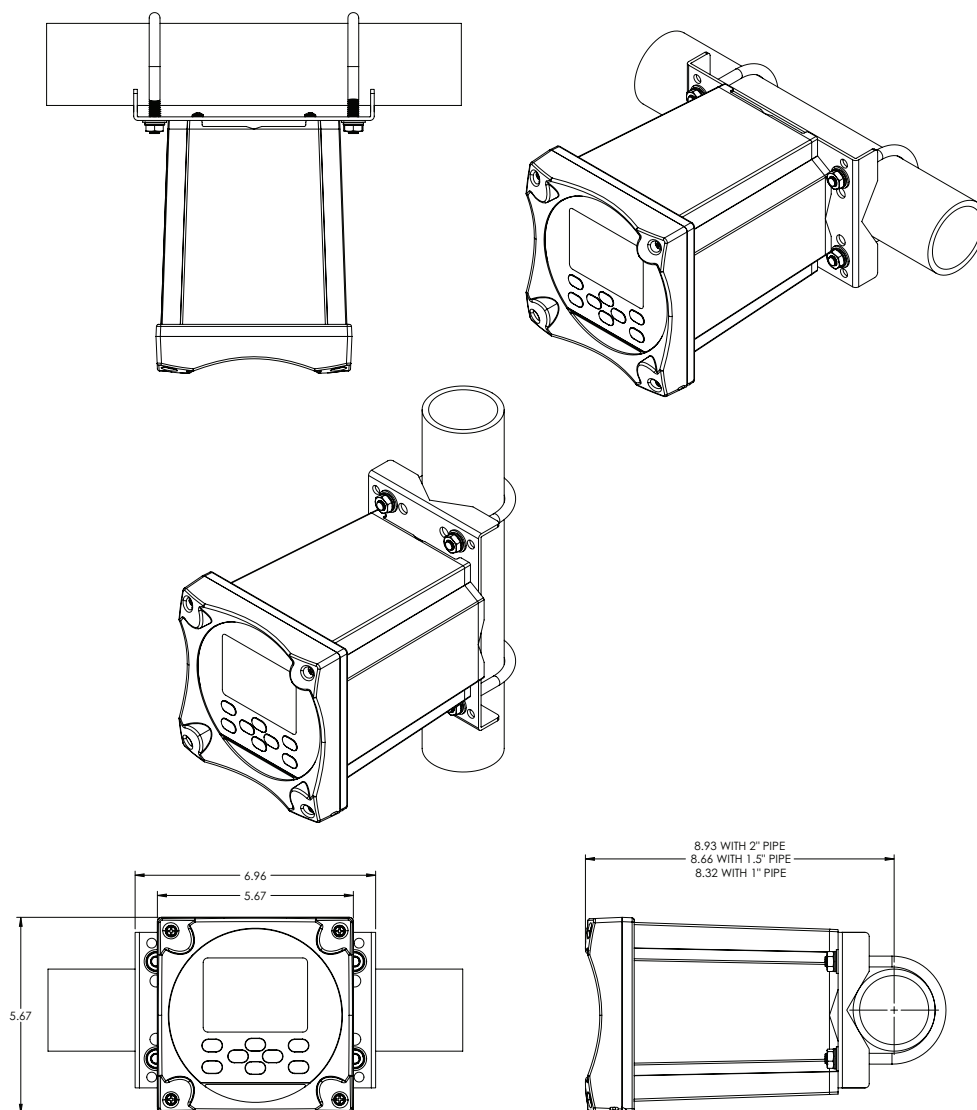

Surface Mounting

Note: All dimensions are in inches.

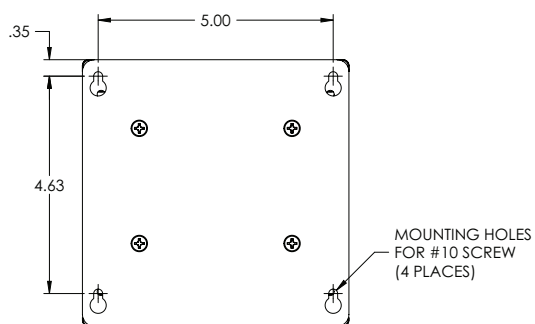
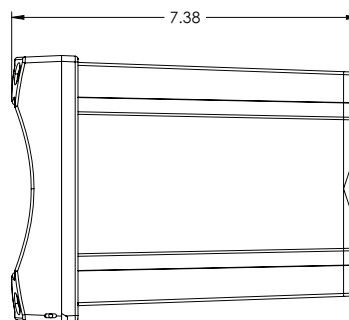
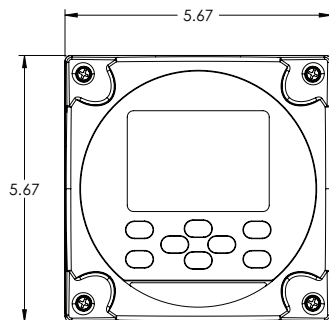
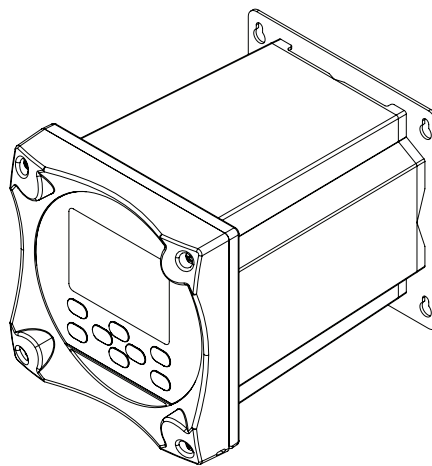



*Thermo Fisher Scientific
Water Analysis Instruments
Chelmsford, MA USA
Quality Management System
Registered to ISO 9001*

thermofisher.com/Water

© 2017 ThermoFisher Scientific Inc. All Rights Reserved Modbus is a registered trademark of Schneider Electric. Kimwipes is a registered trademark of Kimberly-clark and its affiliates. Certified System StandardsMark logo is a trademark of SAI global. All other trademarks are the property of Thermo Fisher Scientific inc. & its subsidiaries.

Water Analysis Instruments

North America

Toll Free: 1-800-225-1480
Tel: 1-978-232-6000
info.water@thermofisher.com

Germany

Tel: (49) 6184-90-6000
info.water.uk@thermofisher.com

India

Tel: (91) 22-4157-8800
wai.asia@thermofisher.com

Japan

Tel: (81) 045-453-9175
wai.asia@thermofisher.com

China

Tel: (86) 21-68654588
wai.asia@thermofisher.com

Singapore

Tel: (65) 6778-6876
wai.asia@thermofisher.com

Australia

Tel: (613) 9757-4300
In Australia: (1300) 735-295
InfoWaterAu@thermofisher.com